



# Fire assessment report

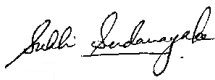


Service penetrations protected by  
Protecta EX Mortar in accordance with  
AS 1530.4:2014 and AS 4072.1:2005

Sponsor: Polyseam Ltd

Report number: 53619700C Revision: R4.2 Reference number: FAS210027

Issued date: 17 May 2021 Expiry date: 30 April 2026

## Quality management

Version	Date	Information about the report			
53619700-C.1	Issue: 16/07/2018	Reason for issue	Initial issue.		
		<b>Prepared by</b>	<b>Reviewed by</b>	<b>Authorised by</b>	
		<b>Name</b>	Mahmoud Akl	Omar Saad	N/A
53619700 C.2	Issue: 14/09/2018	Reason for issue	Revised to include graphite table.		
		<b>Prepared by</b>	<b>Reviewed by</b>	<b>Authorised by</b>	
		<b>Name</b>	Mahmoud Akl	Omar Saad	N/A
53619700 C.3	Issue: 18/09/2018	Reason for issue	Revised for typographical amendments		
		<b>Prepared by</b>	<b>Reviewed by</b>	<b>Authorised by</b>	
		<b>Name</b>	Mahmoud Akl	Omar Saad	N/A
53619700C R4.0	Issue: 26/03/2021	Reason for issue	Revised to include additional test data and additional assessed systems.		
		<b>Prepared by</b>	<b>Reviewed by</b>	<b>Authorised by</b>	
		<b>Name</b>	Sukhi Sendanayake	Mahmoud Akl	Mahmoud Akl
53619700C R4.1	Issue: 23/04/2021	Reason for issue	Revised to address comments from report sponsor.		
		<b>Prepared by</b>	<b>Reviewed by</b>	<b>Authorised by</b>	
		<b>Name</b>	Sukhi Sendanayake	Mahmoud Akl	Mahmoud Akl
53619700C R4.2	Issue: 17/05/2021	Reason for issue	Report re-issued after addressing further comments from report sponsor.		
		<b>Prepared by</b>	<b>Reviewed by</b>	<b>Authorised by</b>	
			<b>Name</b>	Sukhi Sendanayake	Mahmoud Akl
	30/04/2026	<b>Signature</b>			

## Executive summary

This report documents the findings of the assessment undertaken to determine the expected fire resistance levels (FRL) of service penetrations protected with Protecta EX Mortar if tested in accordance with AS 1530.4:2014 and assessed in accordance with AS 4072.1:2005.

Protecta EX Mortar is a gypsum-based mortar material, used to reinstate the fire resistance performance of wall and floor constructions where they have been provided with apertures for the penetrations of multiple services such as cables, trays and metallic, plastic and composite cables. It is supplied as a dry material and is mixed with water to the required ratio prior to installation. When mixed, it is self-supporting in a wall and floor orientation and may be used with or without a permanent mineral fibre backing material depending upon the required application and FRL.

The analysis in sections 5 to 7 of this report found that the proposed systems together with the described variations are likely to achieve the FRLs given, if tested in accordance with AS 1530.4:2014 and assessed in accordance with AS 4072.1:2005.

**Table 1 Variations and assessment outcome**

Item	Reference tests	Variations	Fire resistance levels (FRL)
1	As given in Appendix B	The proposed variation is to assess the likely fire resistance performance if tested in accordance with AS 1530.4:2014 and AS 4072.1:2005.	As provided in section 5.
2.		Assess the performance of various types and sizes of cables, metallic pipes, composite pipes and plastic pipes protected with Protecta EX Mortar and other supplementary fire sealing systems.	As provided in section 6.
3.		Extension of FRLs to intermediate pipe sizes based on the testing of the maximum and minimum pipe size.	
4.		<p>It is proposed that the separating elements are varied as follows:</p> <ul style="list-style-type: none"> <li>• Increase in aperture size for fire seals filled with Protecta EX Mortar</li> <li>• Test results from floors as applicable to walls</li> <li>• The plasterboard wall partition tested shall include the option of lining with two layers of 13 mm thick fire grade plasterboard that has otherwise been tested or assessed as a wall to achieve a FRL -/120/120 on each side of steel or timber framed wall.</li> <li>• Applying test results obtained to masonry, AAC or concrete walls</li> <li>• Wall thickness is reduced from 150 mm to 100 mm for section 6.3.5 and floor thickness is reduced from 150 mm as tested to 100 mm for assessed systems in sections 6.4.5 and 6.4.7.</li> </ul> <p>It is proposed that the integrity rating achieved for insulated pipes can be applied to uninsulated pipes as shown in sections 6.3.3, 6.3.8, 6.4.2 and 6.4.6.</p>	As provided in section 7.

The variations and outcome of this assessment are subject to the limitations and requirements described in sections 2, 3 and 8 of this report. The results of this report are valid until 30 April 2026.

## Contents

1.	Introduction	5
2.	Framework for the assessment	5
2.1	Assessment approach	5
2.2	Declaration	6
3.	Limitations of this assessment	6
4.	Description of the specimen and variations	7
4.1	System description	7
4.2	Referenced test data	9
4.3	Variations to the tested systems	9
5.	Applicability of test results in accordance with AS 1530.4:2014	11
5.1	Description of variation	11
5.2	Methodology	11
5.3	Assessment	11
6.	Fire resistance performance of services protected with Protecta EX Mortar	15
6.1	Description of variation	15
6.2	Methodology	15
6.3	Rigid wall constructions according to 4.1 2) with wall thickness of minimum 150 mm	15
6.4	Rigid floor constructions according to 4.1 2) with floor thickness of minimum 100 mm	30
6.5	Rigid floor constructions according to section 4.1 2) with floor thickness of minimum 120 mm	79
6.6	Rigid floor constructions according to section 4.1 2) with floor thickness of minimum 150 mm	81
6.7	Flexible and rigid wall constructions according to section 4.1 2) with wall thickness of min. 100 mm	87
7.	Assessment 3 – Assessment of specific variations	101
7.1	Description of variation	101
7.2	Methodology	101
7.3	Assessment	101
8.	Validity	104
Appendix A	Drawings and additional information	105
Appendix B	Summary of supporting test data	106

## 1. Introduction

This report documents the findings of the assessment undertaken to determine the expected fire resistance levels (FRL) of service penetrations protected with Protecta EX Mortar if tested in accordance with AS 1530.4:2014<sup>1</sup> and assessed in accordance with AS 4072.1:2005<sup>2</sup>.

This assessment was carried out at the request of Polyseam Ltd. The sponsor details are included in Table 2.

**Table 2 Sponsor details**

Sponsor	Address
Polyseam Ltd	15 St Andrews Road Huddersfield West Yorkshire HD1 6SB UK

## 2. Framework for the assessment

### 2.1 Assessment approach

An assessment is an opinion about the likely performance of a component or element of structure if it was subject to a standard fire test.

No specific framework, methodology, standard or guidance documents exists in Australia for doing these assessments. We have therefore followed the 'Guide to undertaking technical assessments of the fire performance of construction products based on fire test evidence' prepared by the Passive Fire Protection Forum (PFPF) in the UK in 2019<sup>3</sup>.

This guide provides a framework for undertaking assessments in the absence of specific fire test results. Some areas where assessments may be offered are:

- Where a modification is made to a construction which has already been tested
- The interpolation or extrapolation of results of a series of fire resistance tests, or utilisation of a series of fire test results to evaluate a range of variables in a construction design or a product
- Where, for various reasons – eg size or configuration – it is not possible to subject a construction or a product to a fire test.

Assessments will vary from relatively simple judgements on small changes to a product or construction through to detailed and often complex engineering assessments of large or sophisticated constructions.

This assessment uses established empirical methods and our experience of fire testing similar products to extend the scope of application by determining the limits for the design based on the tested constructions and performances obtained. The assessment is an evaluation of the potential fire resistance performance if the elements were to be tested in accordance with AS 1530.4:2014 and assessed in accordance with AS 4072.1:2005.

This assessment has been written using appropriate test evidence generated at accredited laboratories to the relevant test standard. The supporting test evidence has been deemed appropriate to support the manufacturer's stated design.

<sup>1</sup> Standards Australia, 2014, Methods for fire tests on building materials, components and structures – Part 4: Fire-resistance tests for elements of construction, AS 1530.4:2014, Standards Australia, NSW.

<sup>2</sup> Standards Australia, 2005, Components for the protection of openings in fire-resistant separating elements: Service penetrations and control joints, AS 4072.1:2005, Standards Australia, NSW.

<sup>3</sup> Passive Fire Protection Forum (PFPF), 2019, Guide to undertaking technical assessments of the fire performance of construction products based on fire test evidence, Passive Fire Protection Forum (PFPF), UK.

## 2.2 Declaration

The 'Guide to undertaking technical assessments of the fire performance of construction products based on fire test evidence' prepared by the PFPF in the UK requires a declaration from the client. By accepting our fee proposal on 2 February 2021, Polyseam Ltd confirmed that:

- To their knowledge the component or element of structure, which is the subject of this assessment, has not been subjected to a fire test to the standard against which this assessment is being made.
- They agree to withdraw this assessment from circulation if the component or element of structure is the subject of a fire test by a test authority in accordance with the standard against which this assessment is being made and the results are not in agreement with this assessment.
- They are not aware of any information that could adversely affect the conclusions of this assessment and – if they subsequently become aware of any such information – they agree to ask the assessing authority to withdraw the assessment.

## 3. Limitations of this assessment

- The scope of this report is limited to an assessment of the variations to the tested systems described in section 4.3.
- This report details the methods of construction, test conditions and assessed results that are expected if the systems were tested in accordance with AS 1530.4:2014.
- The results of this assessment are applicable to fire exposure from either side for the assessed wall systems and fire exposure from below for the assessed floor systems.
- In systems where insulation installed on metallic and composite pipes is interrupted, it has been established that the insulation does not contribute to the integrity rating of the system. Therefore, assuming insulation is zero, the integrity rating achieved must be maintained when such systems are used on uninsulated pipes.
- While it is recommended that for the elastomeric pipe insulation to be classified B-s3 as tested, the achieved results can be extended to cover an insulation material not deemed combustible as determined by AS 1530.1:1994<sup>4</sup>.
- Support of services in walls and floors must be maintained as per AS 1530.4:2014 and AS 4072.1:2005 requirements.
- This report is only valid for the assessed systems and must not be used for any other purpose. Any changes with respect to size, construction details, loads, stresses, edge or end conditions – other than those identified in this report – may invalidate the findings of this assessment. If there are changes to the system, a reassessment will need to be done by an Accredited Testing Laboratory (ATL).
- The documentation that forms the basis for this report is listed in Appendix A.
- This report has been prepared based on information provided by others. Warringtonfire has not verified the accuracy and/or completeness of that information and will not be responsible for any errors or omissions that may be incorporated into this report as a result.
- This assessment is based on the proposed systems being constructed under comprehensive quality control practices and following appropriate industry regulations and standards on quality of materials, design of structures, guidance on workmanship and the expert handling, placing and finishing of the products on site. These variables are beyond the control and consideration of this report.

---

<sup>4</sup> Standards Australia, 1994, Methods for fire tests on building materials, components and structures – Part 1: Combustibility test for materials, AS 1530.1:1994, Standards Australia, NSW.

## 4. Description of the specimen and variations

### 4.1 System description

Protecta EX Mortar is a gypsum-based mortar material, used to reinstate the fire resistance performance of wall and floor constructions where they have been provided with apertures for the penetrations of multiple services. It is supplied as a dry material and is mixed with water to the required ratio prior to installation. When mixed, it is self-supporting in a wall and floor orientation and may be used with or without a permanent mineral fibre backing material depending upon the required application and FRL.

Protecta FR Pipe Wraps are required to be used in conjunction with Protecta EX Mortar depending upon the required application and FRL.

1. The intended use of Protecta EX Mortar is to reinstate the fire resistance performance of flexible wall, rigid wall and floor constructions where they are penetrated by various cables, trays and metallic, plastic and composite pipes.
2. The specific elements of construction that the system Protecta EX Mortar may be used to provide a penetration seal in, are as follows:
  - a. Flexible walls: The wall must have a minimum thickness of 75 mm or as otherwise specified and comprise steel or timber studs\* on both faces with a minimum 1 layer of 13 mm thick boards, wall are required to be otherwise tested or assessed by other. Apertures are not required to be lined. Further, wall cavity insulation is optional.
  - b. Rigid walls: The wall must have a minimum thickness of 100 mm and comprise concrete, aerated concrete or masonry, with a minimum density of 650 kg/m<sup>3</sup>. Wall elements are required to be otherwise tested or assessed by others.
  - c. Rigid floors: The floor must have a minimum thickness of 100 mm and comprise aerated concrete or concrete with a minimum density of 650 kg/m<sup>3</sup>. Floor elements are required to be otherwise tested or assessed by others.

\*no part of the penetration seal may be closer than 100 mm to a stud, the cavity must be closed between the penetration seal and the stud, and minimum 100 mm of insulation confirmed to be deemed non-combustible in accordance with AS 1530.1:1994<sup>5</sup> must be provided within the cavity between the penetration seal and the stud.

Wall and floor elements are required to be otherwise tested or assessed by others for the required fire resistance period. In cases where the FRL of the wall or floor is less than that of the penetration, the FRL will be derated accordingly.

Protecta Fire Protection Systems which involve services penetrating both sides of a flexible wall may also be used in the situation where the services penetrate one side of the wall only and the remaining side of the wall is not penetrated at the same point (i.e. the services continues on the inside of the wall). All fire integrity and insulation ratings for such single-sided penetrations remain the same as for the equivalent double-sided penetrations for all services except bare metallic pipes. For bare metallic pipes, the thermal insulation ratings will be required to be derated unless a 13 mm or 16 mm baffle system is installed on the unexposed side as per the application.

3. The System Protecta EX Mortar may be used to provide a penetration seal with cables, cable trays, plastic pipes, composite pipes and metallic pipes with and without insulation, with mixed services in the same seal/aperture (for details see section 6).

Test results for the cables remain valid if the diameter of a single cable is reduced and/or the number of cables in a bunch is reduced provided that the overall diameter of the bunch of any individual cable is not greater than that tested.

<sup>5</sup> Standards Australia, 1994, Methods for fire tests on building materials, components and structures – Part 1: Combustibility test for materials, AS 1530.1:1994, Standards Australia, NSW.

The test results obtained with the standard configuration cover all types of insulated cables with copper or aluminium conductors, fibre optic cables and bundled communication cables, except hollow cables.

Results obtained from tests where the supports pass through the seal are applicable to those situations where the support is continued but not vice versa.

The test results obtained using standard configuration for cable penetration systems are valid for:

- i. All types of steel cable trays and ladders
  - ii. Any penetration size equal or smaller than that tested, provided the total amount of cross sections of the cables (core and insulation) does not exceed 60% of the penetration.
4. In systems where insulation installed on metallic and composite pipes is interrupted, it has been established that the insulation doesn't contribute to the integrity rating of the system. Therefore, assuming insulation is zero, the integrity rating achieved must be maintained when such systems are used on uninsulated pipes.
  5. It was confirmed that where PP pipes are mentioned, this includes PP-MV, PP-H, PP-R and similar. Where PE pipes are mentioned, this includes PE-LD, PE-MD, PE-HD, PE-X and similar.
  6. The system Protecta EX Mortar may be used to seal apertures in the separating element up to 2400 mm wide by 1200 mm high in a wall, and 2400 mm by 1200 mm in a floor. The additional sizes that are permitted in floors are:

Width (mm)	Length (mm)
1100	2900
1000	4000
≤ 800	∞ (infinite)

The minimum permitted separation between adjacent seals/apertures is 200 mm. Services within the system Protecta EX Mortar seal do not require a minimum separation, except where specifically detailed in section 6.

7. Support of services in walls and floors must be maintained as per AS 1530.4:2014 and AS 4072.1:2005 requirements.

Refer to section 6 for the assessed FRL given to each construction configuration.



## 4.2 Referenced test data

The assessment of the variation to the tested system and the determination of the likely performance is based on the results of the fire tests documented in the reports summarised in Table 3. Further details of the tested system are included in Appendix B.

**Table 3 Referenced test data**

Report number	Test sponsor	Test date	Testing authority	
WF 416697	Polyseam Ltd	14 August 2019	Warringtonfire, UK	
WF 394948		30 January 2018		
WF 405610		11 October 2018		
WF 405532 Revision A		8 October 2018		
WF 400805		8 November 2018		
WF 400806		25 October 2018		
WF 397686 Revision A		28 March 2018		
WF 392115		16 November 2017		
WF 19324A		31 October 2018		WFGENT, Belgium
WF 375797		9 March 2017		Warringtonfire, UK
WF 375799A	15 January 2016			
WF 375799B	23 March 2017			
WF 379319	2 February 2017			
WF 380963	6 March 2017			
WF 382337	19 April 2017			

## 4.3 Variations to the tested systems

We have assessed the systems using baseline test information for similar systems. The variations to the tested systems – together with the referenced standard fire tests – are described in Table 4.

**Table 4 Variations to tested systems**

Item	Reference tests	Description	Variations
1	As given in Appendix B	The referenced tests were conducted in accordance with BS EN 1366-3:2009 <sup>6</sup> and BS EN 1363-1:2012 <sup>7</sup>	Assess the likely fire resistance performance of the services if tested in accordance with AS 1530.4:2014 and AS 4072.1:2005.
2.		The referenced tests were conducted to demonstrate how Protecta EX Mortar, a gypsum-based mortar material, is used to reinstate the fire resistance performance of flexible wall, rigid wall and floor constructions where they are penetrated by various cables, trays and metallic, plastic and composite pipes.	Assess the performance of various types and sizes of cables, metallic pipes, composite pipes and plastic pipes protected with Protecta EX Mortar and other supplementary fire sealing systems.
3.			Extension of FRLs to intermediate pipe sizes based on the testing of the maximum and minimum pipe size.
4.			The separating elements are varied as follows: <ul style="list-style-type: none"> <li>Increase in aperture size for fire seals filled with Protecta EX mortar</li> </ul>

<sup>6</sup> European Committee for Standardization, 2009, Fire resistance tests for service installations. Penetration seals, BS EN 1366-3:2009, European Committee for Standardization, Brussels, Belgium.

<sup>7</sup> European Committee for Standardization, 2012, Fire resistance tests – General requirements, BS EN 1363-1:2012, European Committee for Standardization, Brussels, Belgium.

Item	Reference tests	Description	Variations
			<ul style="list-style-type: none"> <li>• Test results from floors as applicable to walls.</li> <li>• The plasterboard wall partition assessed shall include the option of lining with two layers of minimum 13 mm thick fire grade plasterboard that has otherwise been tested or assessed as a wall to achieve a FRL -/120/120 on each side of steel or timber framed wall.</li> <li>• Applying test results obtained to masonry, AAC or concrete walls.</li> <li>• Wall thickness is reduced from 150 mm to 100 mm for section 6.3.5 and floor thickness is reduced from 150 mm as tested to 100 mm for assessed systems in sections 6.4.5 and 6.4.7.</li> </ul> <p>The integrity rating achieved for insulated pipes can be applied to uninsulated pipes as shown in sections 6.3.3, 6.3.8, 6.4.2 and 6.4.6.</p>

## 5. Applicability of test results in accordance with AS 1530.4:2014

### 5.1 Description of variation

This assessment report is prepared based on referenced tests provided in Appendix B describing fire resistance testing of fire seals and service penetration protection in various fire separating elements, tested in accordance with BS EN 1363-1:2012, BS EN 1366:3 2009 and BS EN 1366-4:2006. These standards differ from AS 1530.4:2014. The effect these differences have on the fire resistance performance of the test specimens if tested in accordance with AS 1530.4:2014 is discussed below.

### 5.2 Methodology

The method of assessment used is summarised in Table 5.

**Table 5 Method of assessment**

Assessment method	
Level of complexity	Complex assessment
Type of assessment	Qualitative / Comparative

### 5.3 Assessment

#### 5.3.1 Specimen configuration

AS 1530.4:2014 specifies that the service(s) shall be installed so that it projects a minimum 500 mm on each side of the supporting construction, of which at least 200 mm shall extend beyond the extremities of the penetration sealing system. The penetration sealing system shall include any coating, wrapping or other protections to the services. The length of unprotected service on the unexposed face shall not be greater than 500 mm. For plastic pipes, the external projection away from the furnace shall be increased to a minimum of 2000 mm. The measurements shall not include any part of the plug or cap used to seal a pipe within the furnace.

With respect to the pipe end configurations, AS 1530.4:2014 stipulates that services end conditions shall be representative of those intended to be used in practice.

The EN standard stipulates the following field of application based on the tested pipe end configuration:

**Table 6 Field of application rules for pipe end configurations**

		Tested			
		U/U	C/U	U/C	C/C
Covered	U/U	Y	N	N	N
	C/U	Y	Y	N	N
	U/C	Y	Y	Y	N
	C/C	Y	Y	Y	Y

Y=acceptable, N=not acceptable

Based on the review of the test data and the above field of application, it is the opinion of this testing authority that services tested with an open/open end fire configuration are considered to be the worst-case scenario as the hot gases will have a clear path to the unexposed side. As a result, the thermocouple placed on the service will likely record the highest temperature when compared to the rest of the pipe end configurations. Therefore, FRL achieved in U/U configuration can be extended to services tested in any of the pipe end configurations.

With respect to the services tested in an open/closed configuration or closed/closed configuration, it is considered that both configurations are not in line with the general requirement of the

AS 1530.4:2014. However, AS 1530.4:2014 stipulates that “service end conditions shall be representative of those intended to be used in practice”, therefore, it is reasonable to extend the FRL achieved in both configurations provided that they are representative of the system used in practice.

With respect to the difference in the pipe projection from the wall and the floor system, it is considered that this difference will not likely introduce any detrimental effect to the wall system as the plastic pipe is expected to melt in the first few minutes in a test, and once the sealant is activated, this difference can be negligible.

In case of a floor system, it is argued that having a 2000 mm projection out of the floor slab at the unexposed side may include a detrimental effect due to stack effect but it is also argued that 500 mm projection as stipulated in the BS EN standard could also be considered as the most onerous case as more hot gases are expected to pass from the exposed to the unexposed side at a faster rate, hence increasing the temperature recorded by the T/C placed on the service before the activation and closure of the fire rated sealant. In conclusion, considerable amount of research and test history has showed that the extension of the pipe from the unexposed side will not likely have an impact on the performance of the plastic pipes, hence it can be positively assessed.

### 5.3.2 Furnace temperature measurement

The furnace thermocouples specified in AS 1530.4:2014 are type K, mineral insulated metal sheathed (MIMS), with a stainless-steel sheath having a wire of diameter of less than 1.0 mm and an overall diameter of 3 mm. The measuring junction protrudes at least 25 mm from the supporting heat resistant tube.

The furnace thermocouples specified in EN 1363-1:2012 are plate thermometers comprised of an assembly of a folded nickel alloy plate, a thermocouple fixed to it and insulation material. A thermocouple is fixed to the side of the plate facing the specimen, with the thermocouple hot junction protected by a pad of insulating material.

The plate is to be constructed from  $150 \pm 1$  mm long by  $100 \pm 1$  mm wide by  $0.7 \pm 0.1$  mm thick austenitic nickel-based superalloy strips.

The measuring junction is to consist of nickel chromium/nickel aluminium (Type K) wire as defined in EN 60584-1, contained within mineral insulation in a heat-resisting steel alloy sheath of nominal diameter 1 mm to 3 mm, with the hot junctions electrically insulated from the sheath.

The thermocouple hot junction is to be fixed to the geometric centre of the plate in the position by a small steel strip made from the same material as the plate. The steel strip can be welded to the plate – or may be screwed to it – to facilitate replacement of the thermocouple. The strip should be approximately 18 mm by 6 mm if it is spot-welded to the plate and nominally 25 mm by 6 mm if it is to be screwed to the plate. The screw is to be 2 mm in diameter.

The assembly of plate and thermocouple should be fitted with a pad of inorganic insulation material  $97 \pm 1$  mm by  $97 \pm 1$  mm by  $10 \pm 1$  mm thick with a density of  $280 \pm 30$  kg/m<sup>3</sup>.

EN 1363-1:2012 specifies that each plate thermometer shall be at least  $100 \pm 50$  mm from the nearest point of the exposed face of the test construction, whereas AS 1530.4:2014 stipulates a distance of  $100 \pm 10$  mm.

The furnace control thermocouples required by EN 1363-1:2012 are less responsive than those specified by AS 1530.4:2014. This variation in sensitivity can produce a potentially more onerous heating condition for specimens tested to EN 1363-1:2012, particularly when the furnace temperature is changing quickly in the early stages of the test. Furnace temperature regime

The furnace temperature regime for fire resistance tests conducted in accordance with AS1530.4-2014 follows the same trend as EN1363-1:2012

The parameters outlining the accuracy of control of the furnace temperature in AS 1530.4:2014 and BS EN1363-1:2012 are not appreciably different.

### 5.3.3 Furnace pressure regime

It is a requirement of both AS 1530.4:2014 and EN 1363-1:2012 that for vertical elements, the furnace shall be operated so that the neutral pressure plane (a pressure of 0 Pa) is established at a height 500 mm above the notional floor level.

For wall penetrations, AS 1530.4:2014 requires that – if the separating element has a height greater than 1 m – it shall be tested with a pressure of  $20 \pm 3$  Pa at the top of the separating element and that the horizontal penetrating services shall be included in the zone where positive pressure exceeds 10 Pa. EN 1366-3:2009 specifies that a minimum pressure of 20 Pa shall be maintained at the top of the uppermost penetration seal in a vertical supporting construction and that services shall only be included in the zone where the positive pressure exceeds 10 Pa.

Therefore, both standards require that a minimum pressure of 10 Pa be maintained at the lowest point of the lowest service.

It is a requirement of both AS 1530.4:2014 and EN 1363-1:2012 that for horizontal elements, a furnace gauge pressure of 20 Pa is established at a height 100 mm below the floor soffit level.

The parameters outlining the accuracy of control of the furnace pressure in AS 1530.4:2014 and EN 1363.1-:2012 are also not appreciably different.

### 5.3.4 Integrity performance criteria

In accordance with AS 1530.4:2014, while a specimen maintains its insulation performance, the specimen shall be deemed to have failed the integrity criterion if it collapses or sustains flaming on the unexposed face, which can ignite a cotton pad when applied for up to 30 seconds.

A specimen shall be deemed to have failed the integrity criterion in accordance with AS 1530.4:2014 when any of the following occur:

- Sustained flaming for 10 seconds.
- A gap forms that allows the passage of hot gases to the unexposed face and ignites the cotton pad when applied for up to 30 seconds.
- A gap forms that allows the penetration of a 25 mm gap gauge anywhere on the specimen.
- A gap forms that allows a 6 mm × 150 mm gap gauge to penetrate the specimen anywhere on the specimen.

Except for minor variations the integrity criteria in EN 1363.1:1999 are generally applied in a comparable manner. The integrity criteria differ slightly between AS 1530.4:2014 and BS EN 1363-1:2012

### 5.3.5 Specimen temperature measurement

The specimen thermocouple specification of service penetrations is generally the same for AS 1530.4:2014 and BS EN 1366-3:2009.

For the penetration construction considered. AS 1530.4:2014 specifies the following locations for thermocouples to be placed.

- At not less than two points approximately 25 mm from the edge of the hole made for the passage of the service (one in uppermost vertical plane).
- On the surface of the penetrating service, at least two thermocouples located approximately 25 mm from the plane of the general surface of the penetrated element (one in uppermost vertical plane).
- At least two positions 25 mm from the interface of the separating element and main penetration seal.

For penetrating sealing systems, BS EN 1363-1:2012 specifies thermocouples are fixed in generally similar locations on the unexposed face: on the supporting construction and/or seal and on the penetrating service adjacent at the plane of penetration, and on the penetrating service some distance from the plane of penetration.

Based on the above, the effect of the differences on the thermocouple locations of the tested construction and the specifications in AS 1530.4:2014 discussed on case-by-case basis.

### **5.3.6 Insulation performance criteria**

The general insulation criteria of AS 1530.4:2014 and BS EN 1363.1:2012 are not appreciably different.

### **5.3.7 Application of test data to AS 1530.4:2014**

The variations in furnace heating regimes, furnace thermocouples and the responses of the different thermocouples types to the furnace conditions are not expected to have a significant effect on the outcome of the referenced fire resistance test.

In the referenced tests, some specimens were not in accordance with AS 1530.4:2014, especially the capping arrangement of pipes. Those services were included in the assessment with the same end conditions as tested.

Based on the above discussion, it is considered that the results relating to the integrity and insulation performance of the referenced tests can be used as a basis to assess the FRL of the specimens if tested in accordance with AS 1530.4:2014.

## 6. Fire resistance performance of services protected with Protecta EX Mortar

### 6.1 Description of variation

Various service penetrations, including metal pipes, plastic pipes and cables are tested protected with Protecta EX Mortar applied at around the pipe to various depths at the aperture of the separating element. Other local protection systems such as Protecta FR Wrap have also been tested in combination with Protecta EX Mortar.

### 6.2 Methodology

The method of assessment used is summarised in Table 7.

**Table 7 Method of assessment**

Assessment method	
Level of complexity	Complex assessment
Type of assessment	Qualitative / Comparative

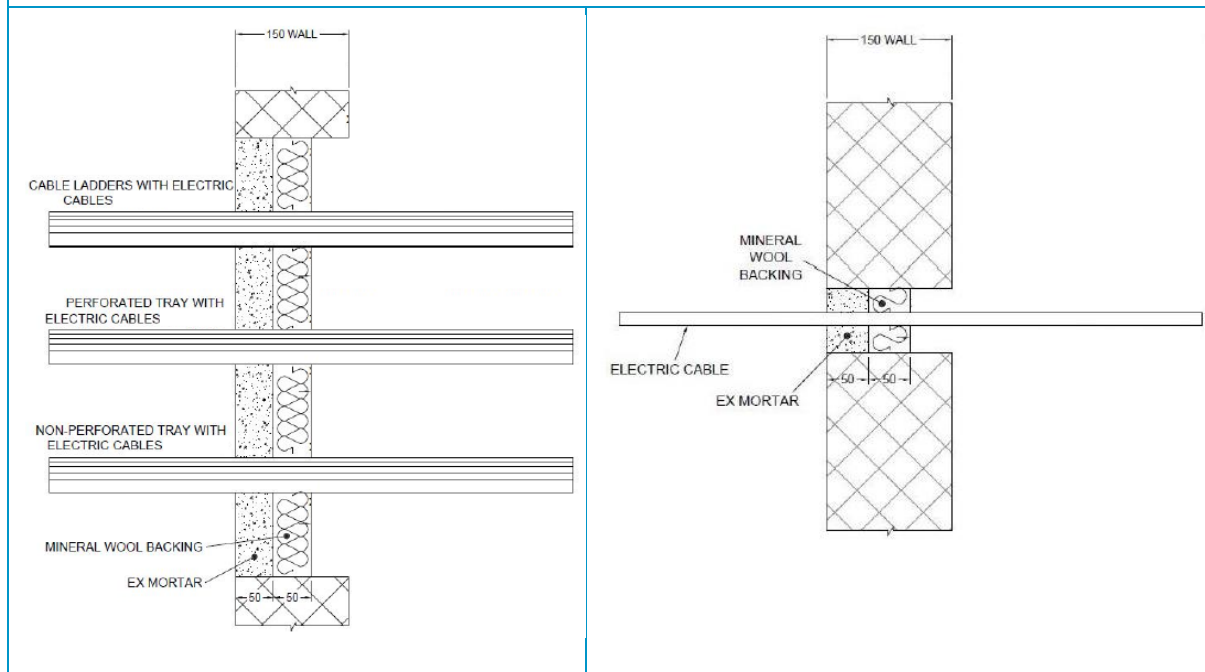
### 6.3 Rigid wall constructions according to 4.1 2) with wall thickness of minimum 150 mm

#### 6.3.1 Cable penetration seal with 50 mm deep Protecta EX Mortar backed with mineral fibre board

##### Penetration seal:

Cables fitted at any position within the aperture (min. separation 25 mm from seal edges), with min. 50 mm Protecta EX Mortar to either side of the wall (or at any position in between), backed with min. 50 mm stone wool board min. 150 kg/m<sup>3</sup>.

##### Construction details:



**Table 8 Single side penetration seal with cables**

Services	Maximum aperture	FRL
None (blank)	As section 4.1 4)	-/180/120
Single electrical cables up to Ø 21 mm		-/180/60
Single electrical cables up to Ø 21 mm	80 mm × 80 mm	-/240/60
Electrical cables up to Ø 21 mm (single, bundled and on trays)	As section 4.1 4)	-/180/60
Electrical cables up to Ø 50 mm (single, bundled and on trays)		-/180/45
Electrical cables up to Ø 80 mm (single, bundled and on trays)		-/120/45
Telecommunication cables up to Ø 21 mm (single or bundles up to Ø 100 mm)		-/180/90
Steel cable trays & ladders		-/180/60
Non-sheathed wires up to Ø 17 mm		-/180/45
Non-sheathed wires up to Ø 24 mm	-/180/30	
Copper conduit up to Ø 16 mm	-/180/30	
Steel conduit up to Ø 16 mm	-/180/60	
PVC conduit up to Ø 16 mm	-/180/60	

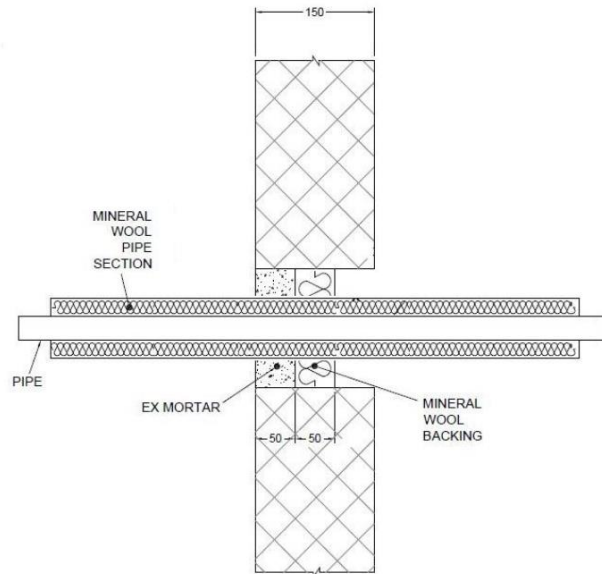


### 6.3.2 Pipe penetration seal with 50 mm deep Protecta EX Mortar backed with mineral fibre board

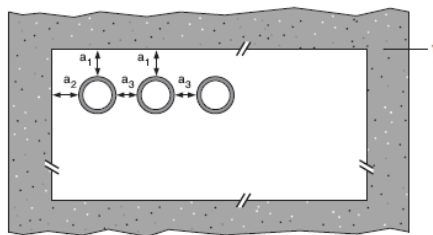
**Penetration seal:**

CS (Continuous Sustained) insulated metallic pipes fitted at any position within the aperture (min. separation 30 mm from seal edges, with min. 50 mm Protecta EX Mortar to either sides of the wall (or any position in between), backed with min. 50 mm stone wool min. 150 kg/m<sup>3</sup>.

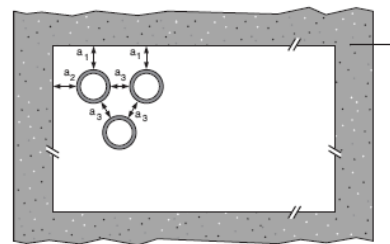
**Construction details:**



**Configuration 1**



**Configuration 2**



**Key**

- 1 Supporting construction
- a1 Pipe / top edge of seal separation
- a2 Pipe / side edge of seal separation
- a3 Pipe / pipe separation

**Table 9 Single side penetration seal with pipes**

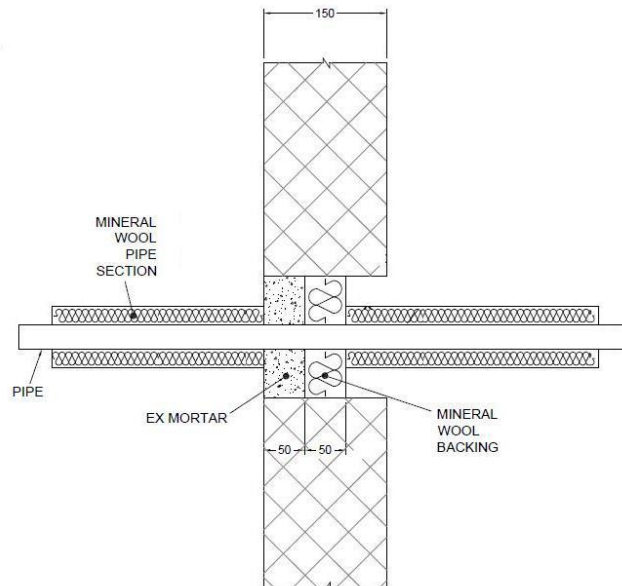
Services	Maximum aperture	Insulation	FRL
Steel pipes 219 diameter/ 5-14.2 mm wall	As section 4.1 4)	30 mm stone wool min. 80 kg/m <sup>3</sup>	-/120/90 C/U

### 6.3.3 Pipe penetration seal with 50 mm deep Protecta EX Mortar backed with mineral fibre board

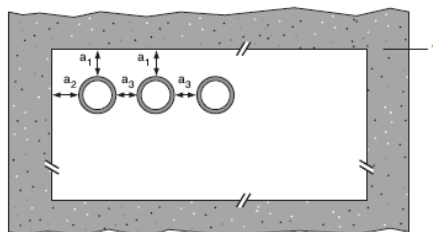
**Penetration seal:**

LI (Local Interrupted) or CI (Continuous Interrupted) insulated metallic and composite pipes fitted at any position within the aperture (min. separation 30 mm from seal edges, with min. 50 mm Protecta EX Mortar to either sides of the wall (or any position in between), backed with min. 50 mm stone wool min. 150 kg/m<sup>3</sup>.

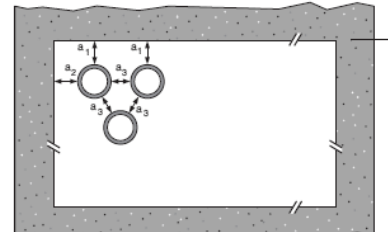
**Construction details:**



**Configuration 1**



**Configuration 2**



**Key**

- 1 Supporting construction
- a1 Pipe / top edge of seal separation
- a2 Pipe / side edge of seal separation
- a3 Pipe / pipe separation

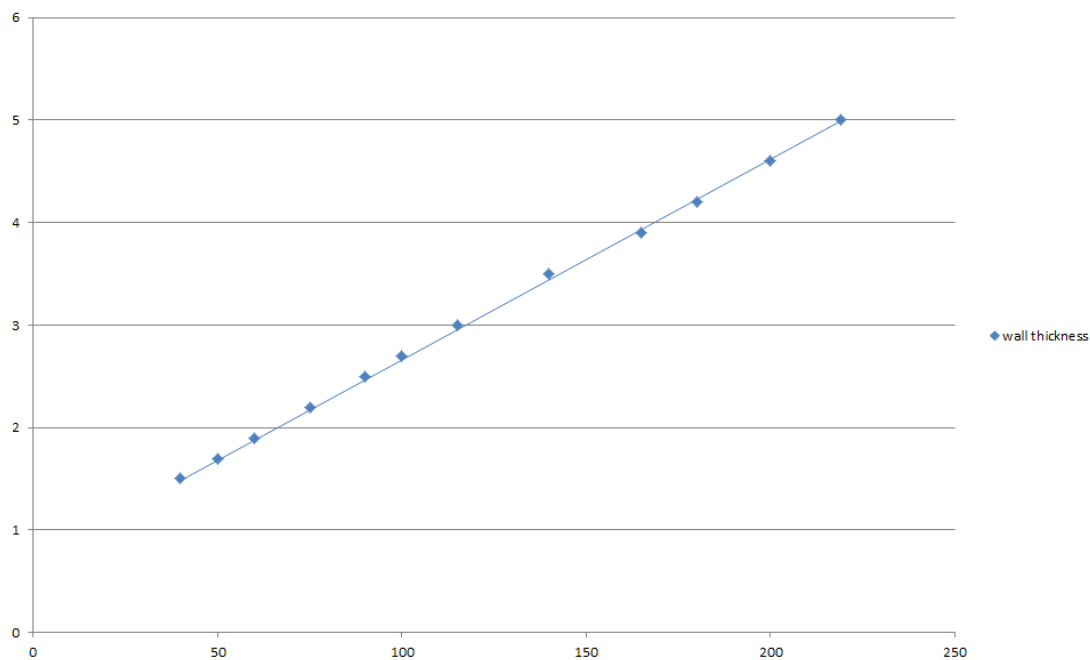
**Table 10 Single side penetration seal with pipes**

Services	Maximum aperture	Insulation, minimum length, thickness and density	FRL
Copper or steel pipes up to 12 mm diameter/ 0.9-5 mm wall	70 mm × 70 mm	1000 mm long, 20 mm stone wool 80 kg/m <sup>3</sup>	-/240/240 C/C
Copper or steel pipes up to 54 mm diameter/ 1-14.2 mm wall	115 mm × 115 mm	1000 mm long, 20 mm stone wool 80 kg/m <sup>3</sup>	-/240/120 C/C
Copper or steel pipes up to 54 mm diameter/ 1-14.2 mm wall	As section 4.1 4)	1000 mm long, 20 mm stone wool 80 kg/m <sup>3</sup>	-/180/120 C/C
75 mm Alupex composite pipes with 7.5 mm wall		600 mm long, 32 mm Elastomeric insulation minimum class B-s3,d0	-/60/60 C/C

**Table 11 Single side penetration seal with pipes**

Services	Maximum aperture	Insulation	FRL
<b>Mild or stainless steel pipe</b>			
40 mm diameter/1.5-14.2 mm wall*	100 mm × 100 mm	1000 mm long, 20 mm stone wool 80 kg/m <sup>3</sup>	-/240/240 C/U
40 mm diameter/1.5-14.2 mm wall*	As section 4.1 4)		-/180/120 C/U
40 mm diameter/1.5-14.2 mm wall*		1000 mm long, 30 mm stone wool 80 kg/m <sup>3</sup>	-/120/90 C/U
50 mm diameter/1.7-14.2 mm wall*			
60 mm diameter/1.9-14.2 mm wall*			
75 mm diameter/2.2-14.2 mm wall*			
90 mm diameter/2.5-14.2 mm wall*			
100 mm diameter/2.7-14.2 mm wall*			
115 mm diameter/3.0-14.2 mm wall*			
140 mm diameter/3.5-14.2 mm wall*			
165 mm diameter/3.9-14.2 mm wall*			
180 mm diameter/4.2-14.2 mm wall*			
200 mm diameter/4.6-14.2 mm wall*			
219 mm diameter/5.0-14.2 mm wall*			
*Typical pipe diameters shown, see below graph for intermediate sizes			

**Pipe diameter vs Wall thickness**



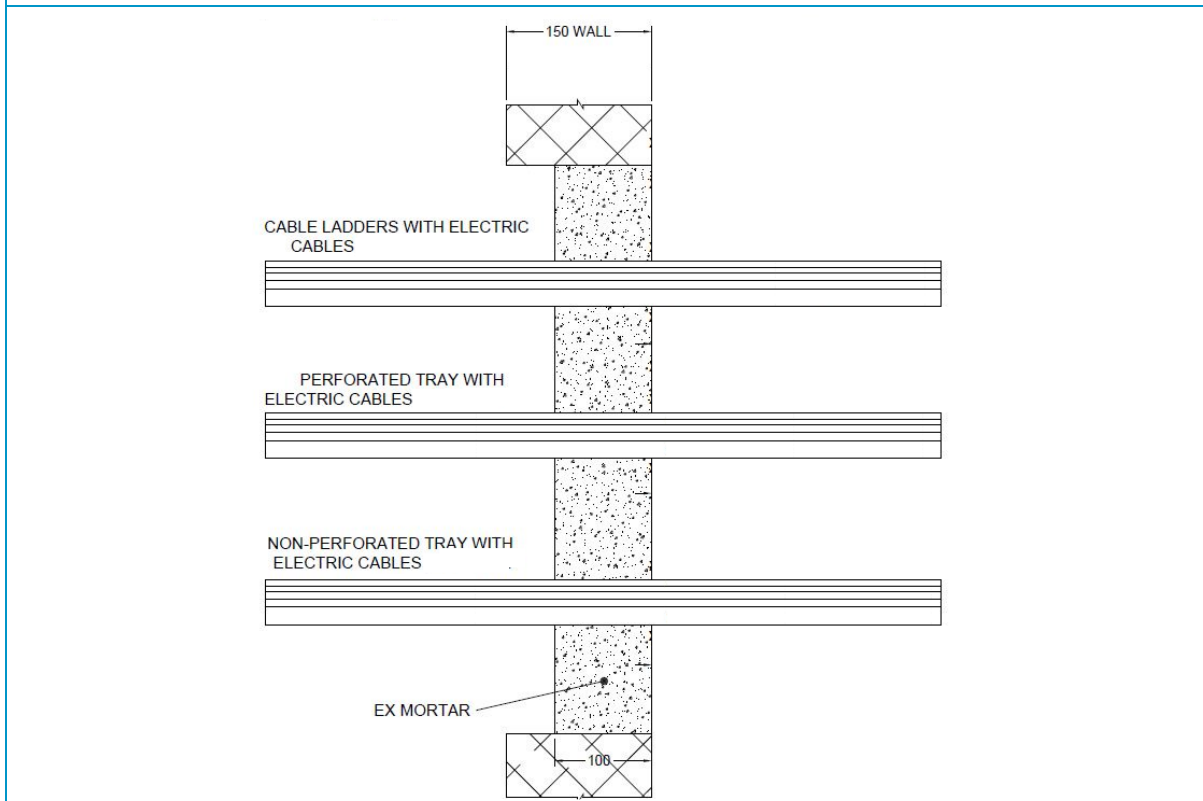
**Figure 1 Intermediate pipe wall thicknesses for typical mild or stainless steel pipe diameters**

### 6.3.4 Cable penetration seal with 100 mm deep Protecta EX Mortar

**Penetration seal:**

Cables fitted at any position within the aperture (min. separation 25 mm from seal edges), with min. 100 mm Protecta EX Mortar to either side of the wall (or at any position in between).

**Construction details:**



**Table 12 Single side penetration seal with cables**

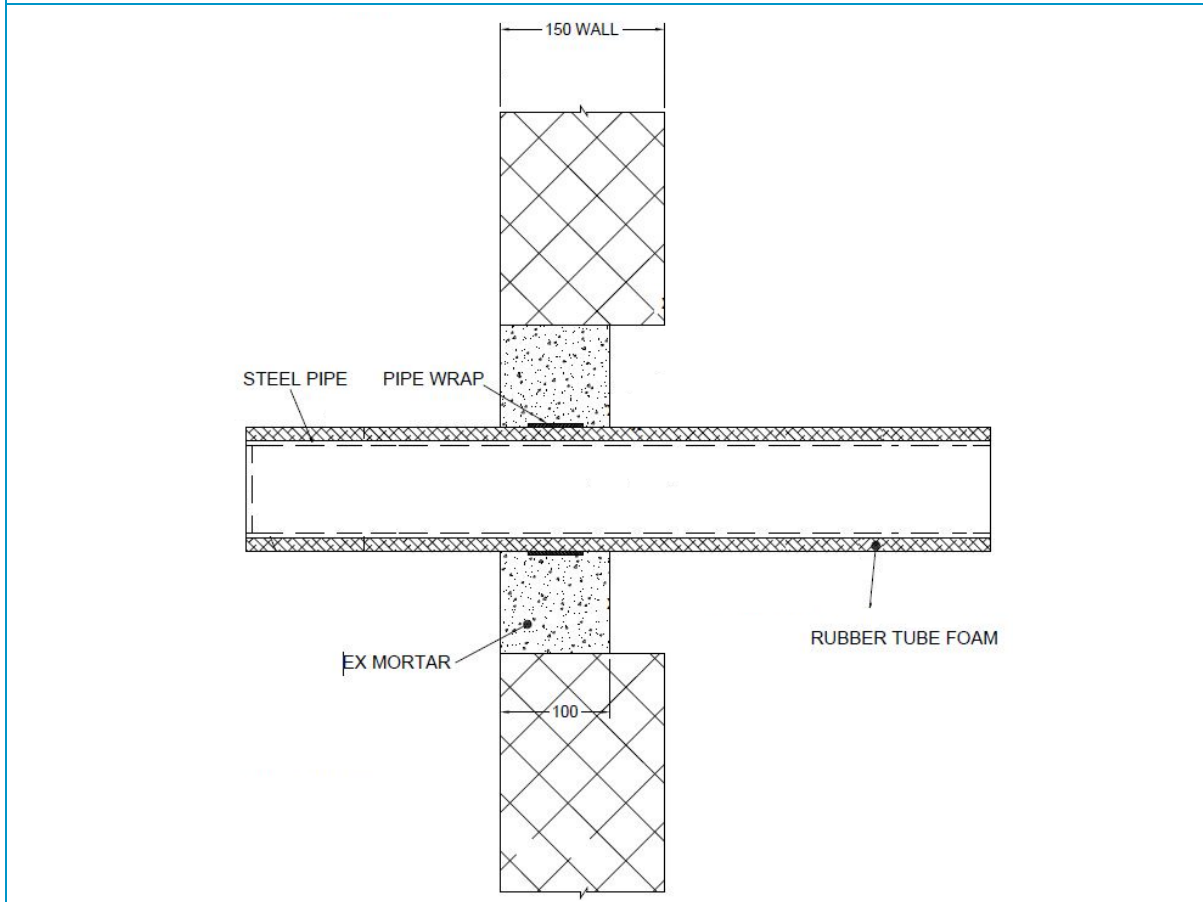
Services	Maximum aperture	FRL
None (blank)	As section 4.1 4)	-/240/240
Electrical cables up to Ø 21 mm (single, bundled an on trays)		-/240/60
Electrical cables up to Ø 80 mm (single, bundled an on trays)		-/120/120
Cables up to Ø 21 mm in tied bundles up to Ø 100 mm Ø		-/120/60
Steel cable trays & ladders		-/180/30 C/U
Non-sheathed cables up to Ø 24 mm Ø		-/180/60 C/U
Copper conduit up to Ø 16 mm		-/240/240 C/C
Steel conduit up to Ø 16 mm		
PVC conduit up to Ø 16 mm		

### 6.3.5 Pipe penetration seal with 100 mm deep Protecta EX Mortar

**Penetration seal:**

CS (Continuous Sustained) insulated metallic pipes fitted at any position within the aperture (min. separation 10 mm from seal edges), with min. 100 mm Protecta EX Mortar to either side of the wall. Protecta FR Pipe wraps are required to be centrally within the seal for pipes with combustible insulation. Maximum seal size as section 4.1 4).

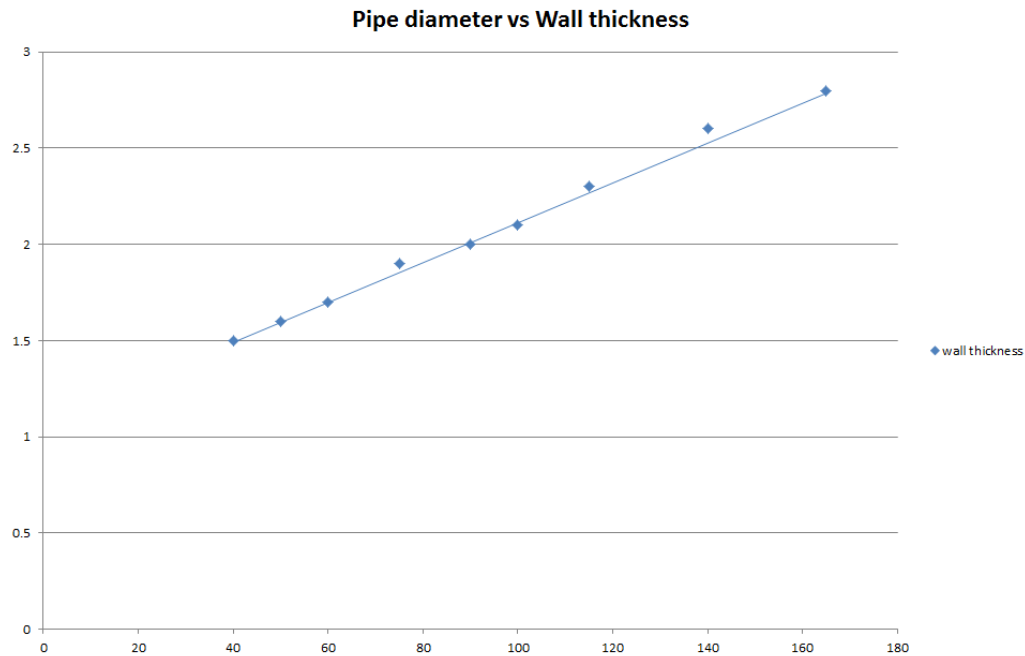
**Construction details:**



**Table 13 Single side penetration seal with pipes**

Services	Wrap	Insulation	FRL
<b>Mild or stainless steel pipe</b>			
40 mm diameter/ 1.5-14.2 mm wall	1 off 50 mm × 3.6 mm Protecta FR Pipe Wrap, fitted central	13 mm Elastomeric insulation minimum class B-s3, d0	-/240/240 C/U
165 mm diameter/4.5-14.2 mm wall		9 mm Elastomeric insulation minimum class B-s3, d0	-/240/30 C/U
40 mm diameter/1.5-14.2 mm wall*	1 off 50 mm × 1.8mm Protecta FR Pipe Wrap, fitted central	13-19mm Elastomeric insulation minimum class B-s3, d0	-/240/60 C/U
50 mm diameter/1.5-14.2 mm wall*			
60 mm diameter/1.5-14.2 mm wall*			
75 mm diameter/1.5-14.2 mm wall*			
90 mm diameter/1.5-14.2 mm wall*			
100 mm diameter/1.5-14.2 mm wall*			
115 mm diameter/2.3-14.2 mm wall*			
140 mm diameter/2.6-14.2 mm wall*			

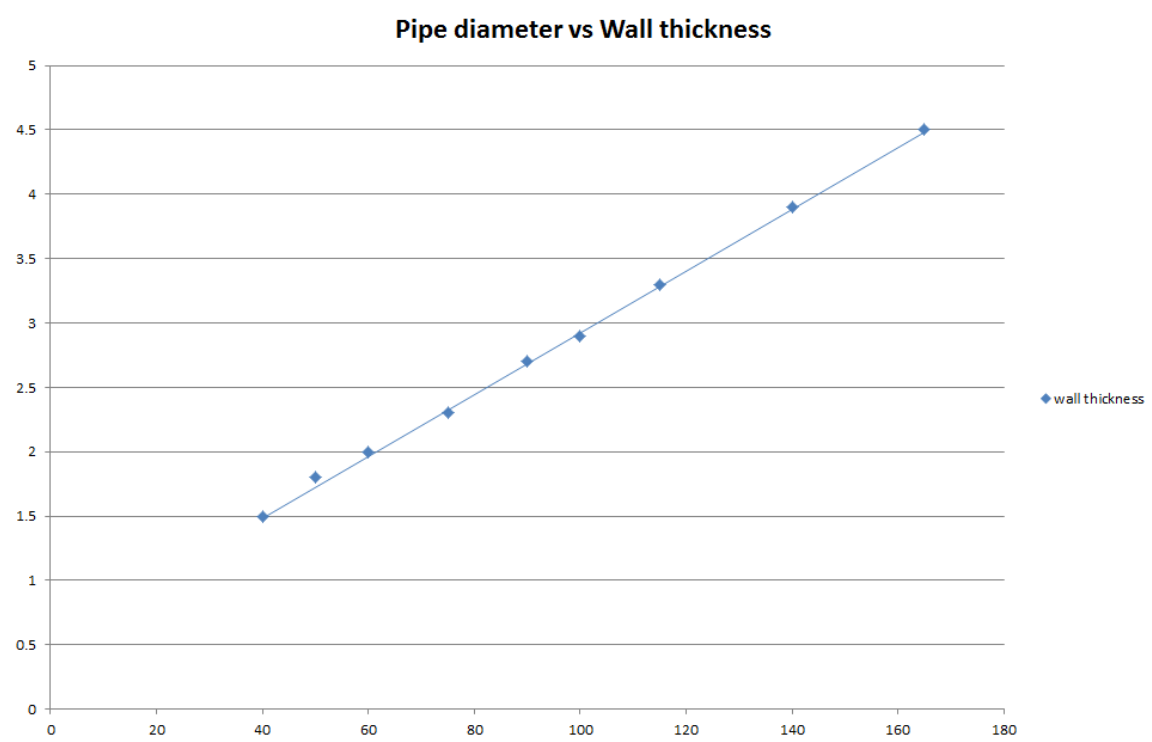
Services	Wrap	Insulation	FRL
165 mm diameter/2.8-14.2 mm wall*			
*Typical pipe diameters shown, see below graph for intermediate sizes			



**Figure 2** Intermediate pipe wall thicknesses for typical mild or stainless steel pipe diameters

**Table 14** Single side penetration seal with pipes

Services	Wrap	Insulation	FRL
<b>Mild or stainless steel pipe</b>			
40 mm diameter/1.5-14.2 mm wall*	1 off 50 mm × 3.6 mm Protecta FR Pipe Wrap, fitted central	13-25 mm Elastomeric insulation minimum class B-s3, d0	-/180/60 C/U
50 mm diameter/1.8-14.2 mm wall*			
60 mm diameter/2-14.2 mm wall*			
75 mm diameter/2.3-14.2 mm wall*			
90 mm diameter/2.7-14.2 mm wall*			
100 mm diameter/2.9-14.2 mm wall*			
115 mm diameter/3.3-14.2 mm wall*			
140 mm diameter/3.9-14.2 mm wall*			
165 mm diameter/4.5-14.2 mm wall*			
*Typical pipe diameters shown, see below graph for intermediate sizes			



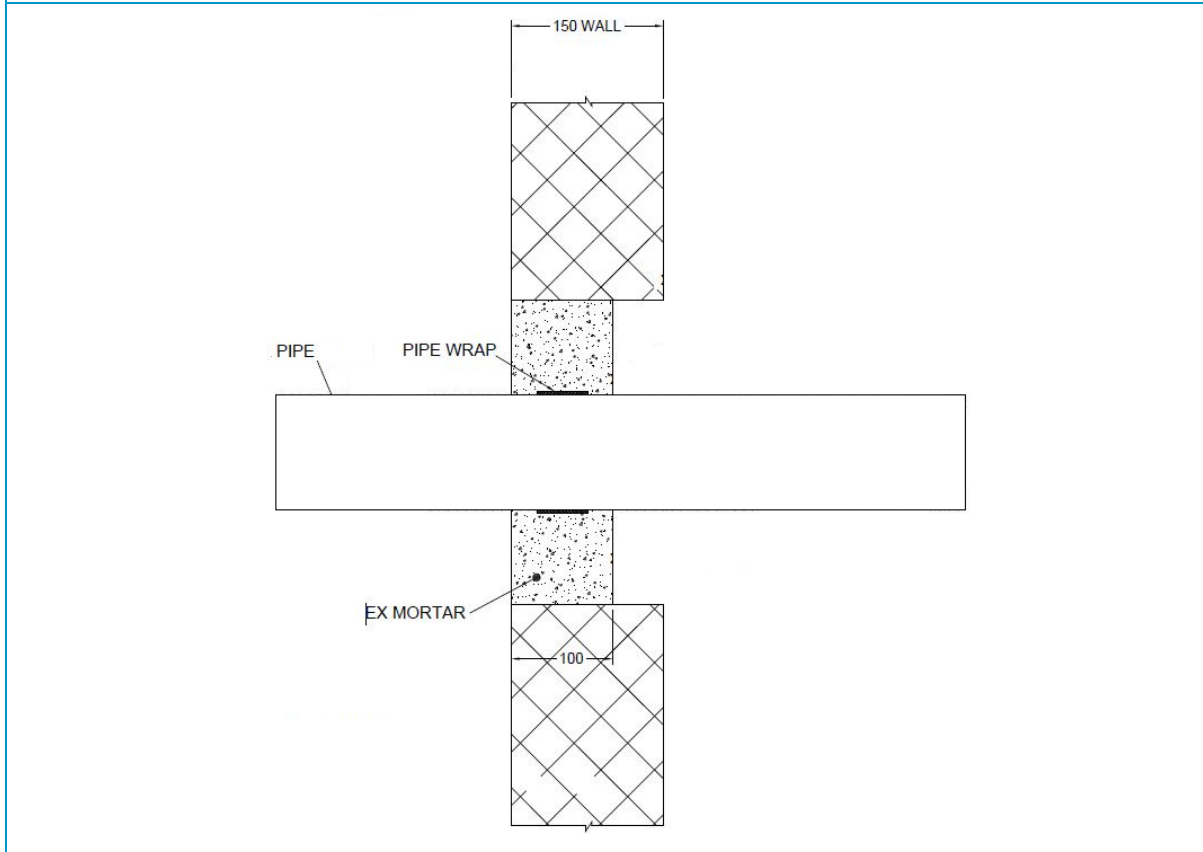
**Figure 3** Intermediate pipe wall thicknesses for typical mild or stainless steel pipe diameters

### 6.3.6 Pipe penetration seal with 100 mm deep Protecta EX Mortar

**Penetration seal:**

Plastic pipes fitted at any position within the aperture (min. separation 10 mm from seal edges), with min. 100 mm Protecta EX Mortar to either side of the wall. Protecta FR Pipe wraps are required to be centrally within the seal. Maximum seal size as section 4.1 4)

**Construction details:**



**Table 15 Single side penetration seal with pipes**

Services	Wrap	Insulation	FRL
<b>PVC-U pipes</b>			
315 mm diameter/9.2 mm wall	1 off 75 mm × 18 mm Protecta FR Pipe Wrap, fitted central	None	-/120/120 C/C

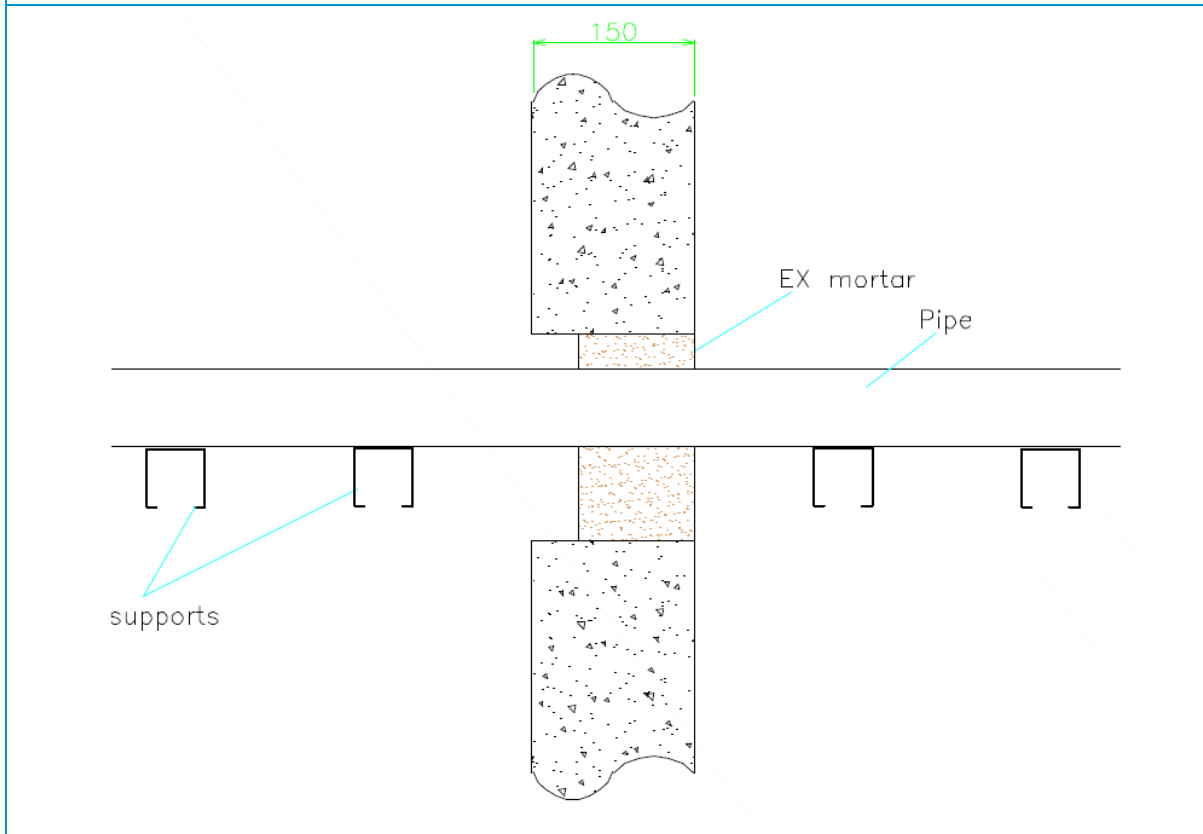


### 6.3.7 Pipe penetration seal with 100 mm deep Protecta EX Mortar

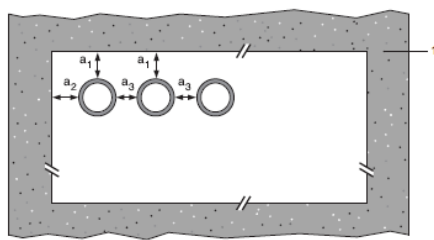
**Penetration seal:**

Combustible pipes sealed with Protecta EX Mortar, to either side of the wall. Minimum separation between pipes of 30 mm (a3) and from seal edges 30 mm (a1 & a2). Maximum seal size as section 4.1 4).

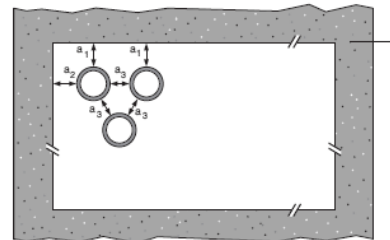
**Construction details:**



**Configuration 1**



**Configuration 2**



**Key**

- 1 Supporting construction
- a1 Pipe / top edge of seal separation
- a2 Pipe / side edge of seal separation
- a3 Pipe / pipe separation

**Table 16 Single side penetration seal with pipes**

Services	Seal depth, minimum	Permitted configuration for seal separation	FRL
<b>PVC-U pipes</b>			
Diameter up to 32 mm, wall thickness 1.6 – 2.4 mm	100 mm	1 & 2	-/120/120 U/C C/C

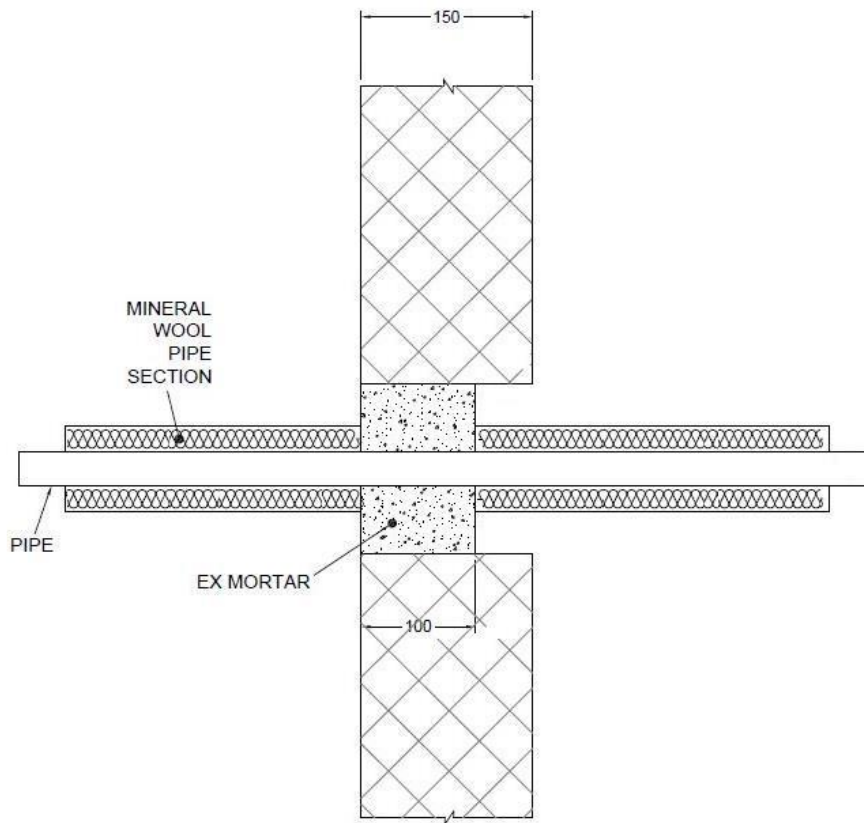
Services	Seal depth, minimum	Permitted configuration for seal separation	FRL
<b>PE pipes</b>			
Diameter up to 32 mm, wall thickness 1.8 – 3.0 mm	100 mm	1 & 2	-/120/120 U/C C/C
<b>PP pipes</b>			
Diameter up to 32 mm, wall thickness 1.9 – 4.4 mm	100 mm	1 & 2	-/120/120 U/C C/C

### 6.3.8 Pipe penetration seal with 100 mm deep Protecta EX Mortar

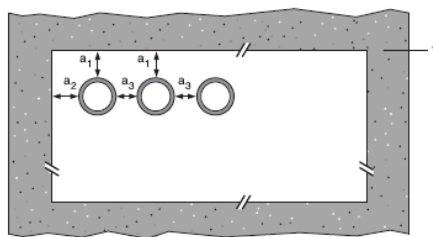
**Penetration seal:**

1000 mm (min.) LI (Local Interrupted) or CI (Continuous Interrupted) insulated metallic pipes fitted at any position within the aperture (min. separation 20 mm from seal edges, with min. 100 mm Protecta EX Mortar to either sides of the wall (or any position in between).

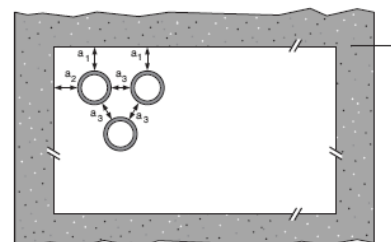
**Construction details:**



**Configuration 1**



**Configuration 2**



**Key**

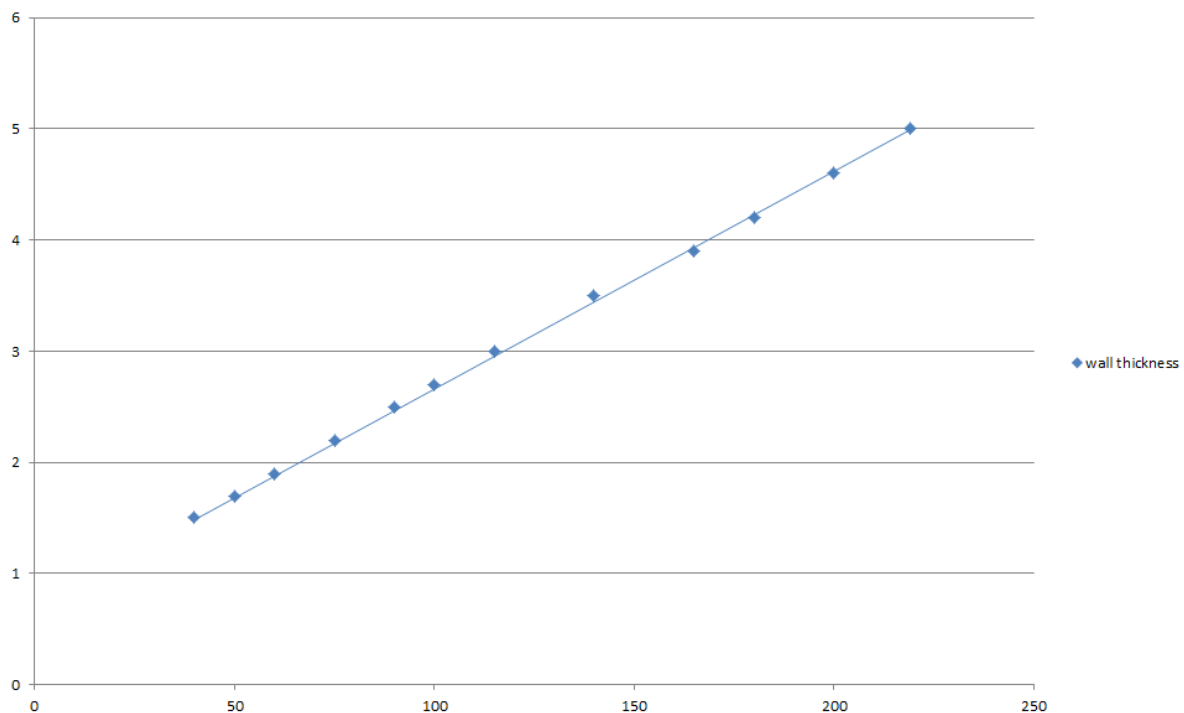
- 1 Supporting construction
- a1 Pipe / top edge of seal separation
- a2 Pipe / side edge of seal separation
- a3 Pipe / pipe separation

**Table 17 Single side penetration seal with pipes**

Services	Maximum aperture	Insulation	FRL
<b>Mild or stainless steel pipes</b>			
40 mm diameter/1.5-14.2 mm wall*	As section 4.1 4)	20 mm Stone wool insulation 80 kg/m <sup>3</sup>	-/240/240 C/U

Services	Maximum aperture	Insulation	FRL
40 mm diameter/1.5-14.2 mm wall*		30 mm Stone wool insulation 80 kg/m <sup>3</sup>	-/240/120 C/U
50 mm diameter/1.7-14.2 mm wall*			
60 mm diameter/1.9-14.2 mm wall*			
75 mm diameter/2.2-14.2 mm wall*			
90 mm diameter/2.5-14.2 mm wall*			
100 mm diameter/2.7-14.2 mm wall*			
115 mm diameter/3-14.2 mm wall*			
140 mm diameter/3.5-14.2 mm wall*			
165 mm diameter/3.9-14.2 mm wall*			
180 mm diameter/4.2-14.2 mm wall*			
200 mm diameter/4.6-14.2 mm wall*			
219 mm diameter/5.0-14.2 mm wall*			
*Typical pipe diameters shown, see below graph for intermediate sizes			

**Pipe diameter vs Wall thickness**



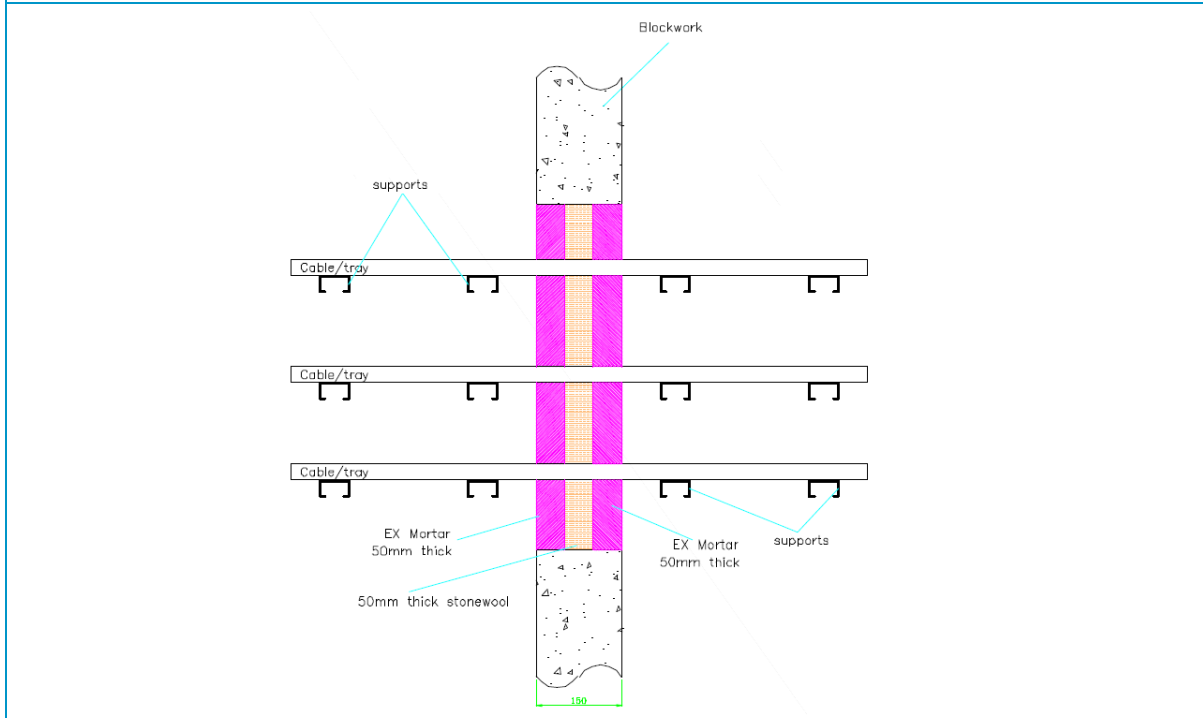
**Figure 4 Intermediate pipe wall thicknesses for typical mild or stainless steel pipe diameters**

### 6.3.9 Pipe penetration seal with 50 mm deep Protecta EX Mortar to both faces

**Penetration seal:**

Cables fitted with Protecta EX Mortar to both sides of the wall, backed with stone wool insulation board min. 150 kg/m<sup>3</sup>. Maximum seal size as section 4.1 4) and minimum separation between cables and the edge of the seal of 30 mm.

**Construction details:**



**Table 18 Single side penetration seal with pipes**

Services	Mortar Depth	Backing	Insulation	FRL
Blank seals	Minimum 50 mm	Minimum 50 mm Stone wool 150 kg/m <sup>3</sup>	None	-/240/240
Electric cables up to 80 mm diameter, single or in a bundle				-/240/60
Steel cable trays and ladders up to 500 mm wide				
Telecoms cables up to 21 mm diameter, single or in a bundle up to 100 mm diameter				-/60/60
Unsheathed wire up to 24 mm diameter				-/240/120

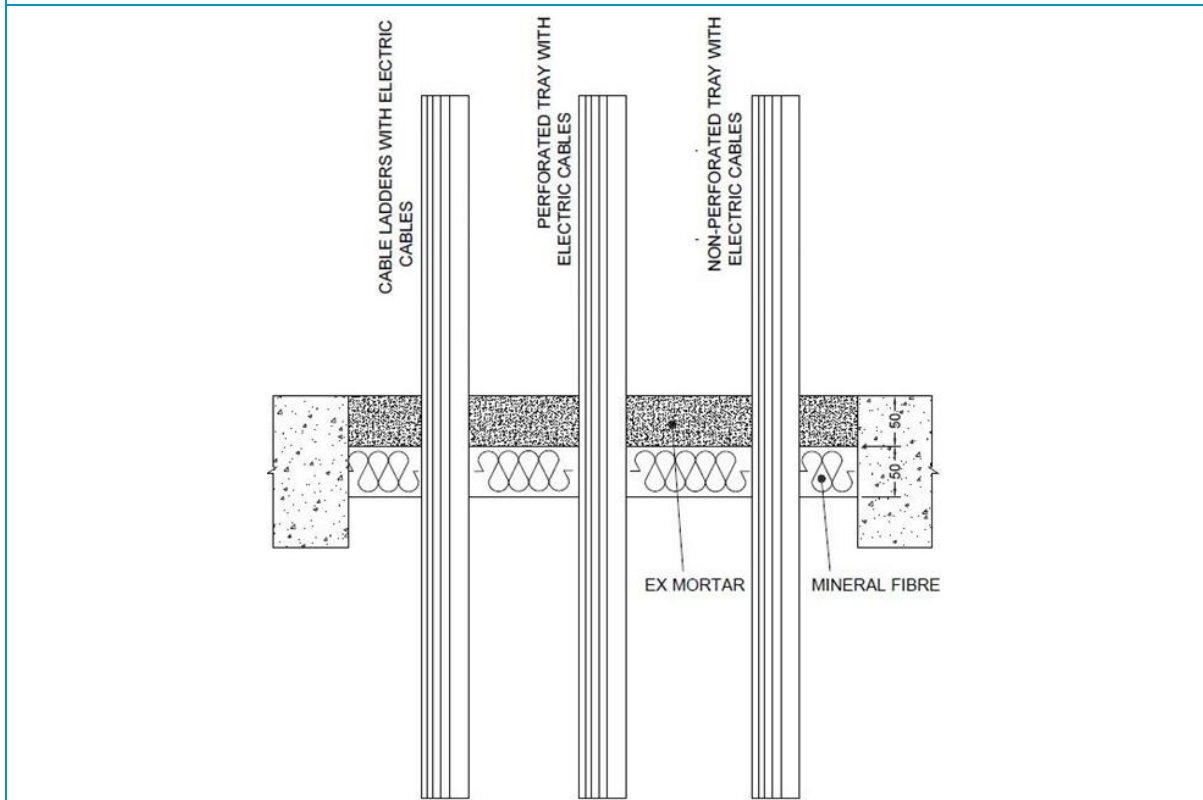
## 6.4 Rigid floor constructions according to 4.1 2) with floor thickness of minimum 100 mm

### 6.4.1 Cable penetration seal with 50 mm deep Protecta EX Mortar backed with mineral fibre board

**Penetration seal:**

Cables fitted at any position within the aperture (min. separation 30 mm from seal edges), with min. 50 mm. Protecta EX Mortar flush with the top of the floor, backed with min. 50 mm stone wool min. 150 kg/m<sup>3</sup>.

**Construction details:**



**Table 19 Single side penetration seal with cables**

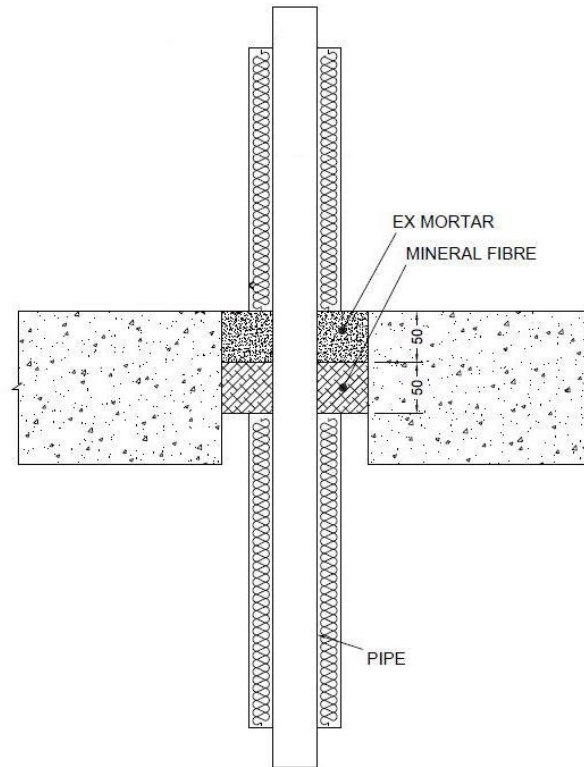
Services	Maximum aperture	FRL
None (blank)	As section 4.1 4)	-/180/180
Single* electrical cables up to Ø 21 mm		-/180/90
Electrical cables up to Ø 21 mm (single, bundled and on trays)		-/180/60
Electrical cables up to 80 mm (single, bundled and on trays)		-/90/45
Cables up to Ø 21 mm in tied bundles up to Ø 100 mm		-/180/180
Steel cable trays & ladders		-/90/60
Non-sheathed wires up to Ø 17 mm		-/180/60
Non-sheathed wires up to Ø 24 mm		-/180/30
PVC conduits up to Ø 16 mm		-/180/180 C/U, C/C
*To be separated by at least 30 mm		

### 6.4.2 Pipe penetration seal with 50 mm deep Protecta EX Mortar backed with mineral fibre board

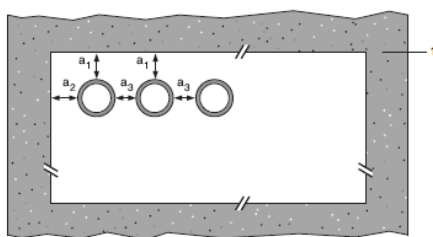
**Penetration seal:**

1000 mm (min.) LI (Local Interrupted) or CI (Continuous Interrupted) insulated metallic pipes fitted at any position within the aperture (min. separation 30 mm from seal edges, with min. 50 mm Protecta EX Mortar flush with the top of floor, backed with min. 50 mm stone wool min. 150 kg/m<sup>3</sup>).

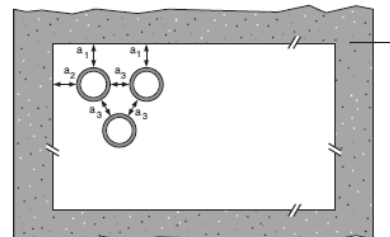
**Construction details:**



**Configuration 1**



**Configuration 2**



**Key**

- 1 Supporting construction
- a1 Pipe / top edge of seal separation
- a2 Pipe / side edge of seal separation
- a3 Pipe / pipe separation

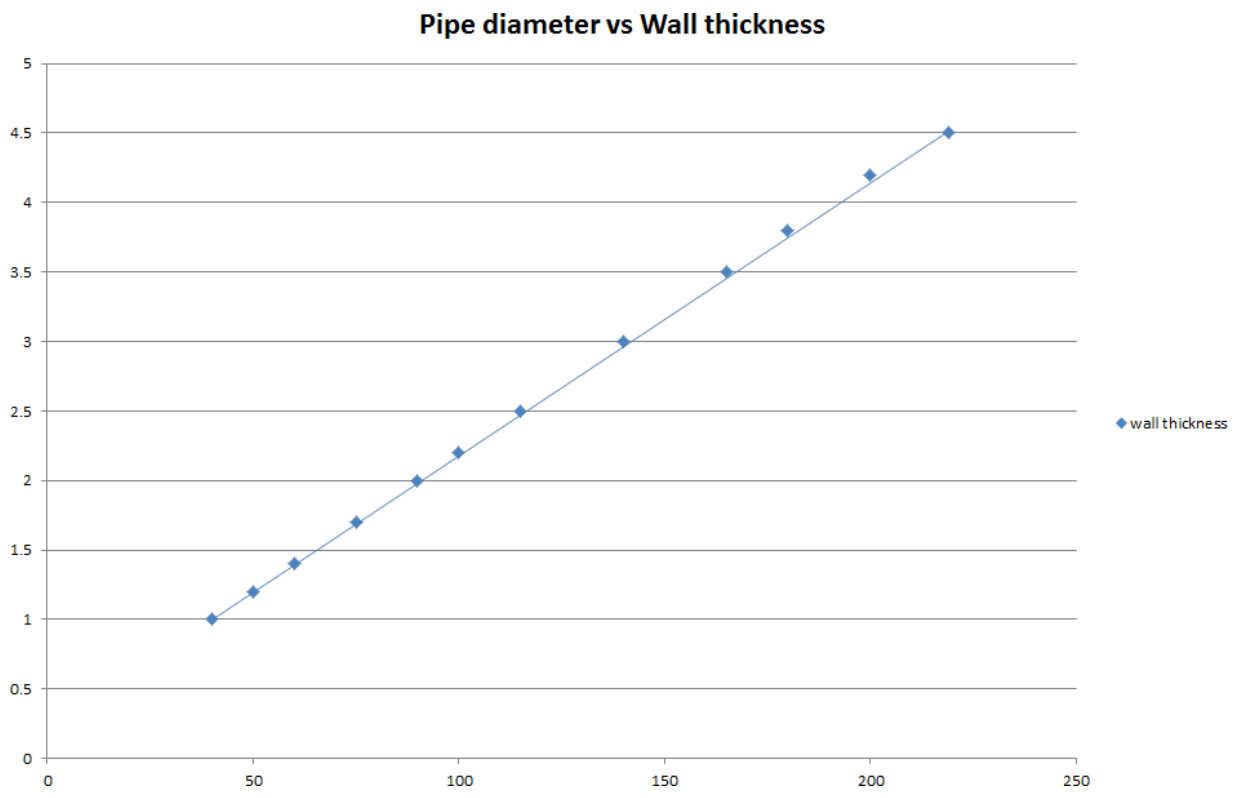
**Table 20 Single side penetration seal with pipes**

Services	Maximum aperture	Insulation, minimum thickness and density	FRL
Copper or steel pipes up to 12 mm diameter/ 1-5 mm wall	70 mm × 70 mm	20 mm stone wool 80 kg/m <sup>3</sup>	-/240/240 C/C
Copper or steel pipes up to 54 mm diameter/ 1-14.2 mm wall	115 mm × 115 mm		-/240/180 C/C
Copper or steel pipes up to 54 mm diameter/1-14.2 mm wall	As section 4.1 4)		-/180/180 C/C

**Table 21 Single side penetration seal with pipes**

Services	Maximum aperture	Insulation, minimum thickness and density	FRL
<b>Mild or stainless steel pipes</b>			
40 mm diameter/1-14.2 mm wall*	280 mm × 280 mm	20 mm Stone wool insulation 80 kg/m <sup>3</sup>	-/240/240 C/U
40 mm diameter/1-14.2 mm wall*		30 mm Stone wool insulation 80 kg/m <sup>3</sup>	-/240/90 C/U
50 mm diameter/1.2-14.2 mm wall*			
60 mm diameter/1.4-14.2 mm wall*			
75 mm diameter/1.7-14.2 mm wall*			
90 mm diameter/2-14.2 mm wall*			
100 mm diameter/2.2-14.2 mm wall*			
115 mm diameter/2.5-14.2 mm wall*			
140 mm diameter/3-14.2 mm wall*			
165 mm diameter/3.5-14.2 mm wall*			
180 mm diameter/3.8-14.2 mm wall*			
200 mm diameter/4.2-14.2 mm wall*			
219 mm diameter/4.5-14.2 mm wall*			
*Typical pipe diameters shown, see below graph for intermediate sizes			



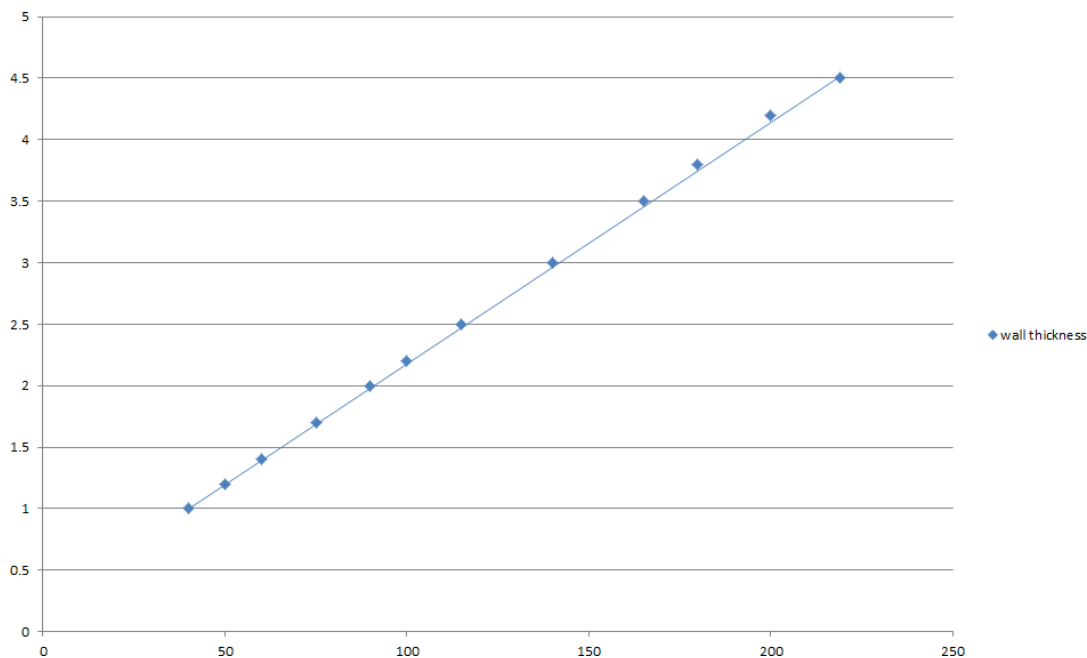


**Figure 5** Intermediate pipe wall thicknesses for typical mild or stainless steel pipe diameters

**Table 22 Single side penetration seal with pipes**

Services	Maximum aperture	Insulation, minimum thickness and density	FRL
<b>Mild or stainless steel pipes</b>			
40 mm diameter/1-14.2 mm wall*	As section 4.1 4)	20 mm Stone wool insulation 80 kg/m <sup>3</sup>	-/180/180 C/U
40 mm diameter/1-14.2 mm wall*		30 mm Stone wool insulation 80 kg/m <sup>3</sup>	-/180/90 C/U
50 mm diameter/1.2-14.2 mm wall*			
60 mm diameter/1.4-14.2 mm wall*			
75 mm diameter/1.7-14.2 mm wall*			
90 mm diameter/2-14.2 mm wall*			
100 mm diameter/2.2-14.2 mm wall*			
115 mm diameter/2.5-14.2 mm wall*			
140 mm diameter/3-14.2 mm wall*			
165 mm diameter/3.5-14.2 mm wall*			
180 mm diameter/3.8-14.2 mm wall*			
200 mm diameter/4.2-14.2 mm wall*			
219 mm diameter/4.5-14.2 mm wall*			
*Typical pipe diameters shown, see below graph for intermediate sizes			

**Pipe diameter vs Wall thickness**



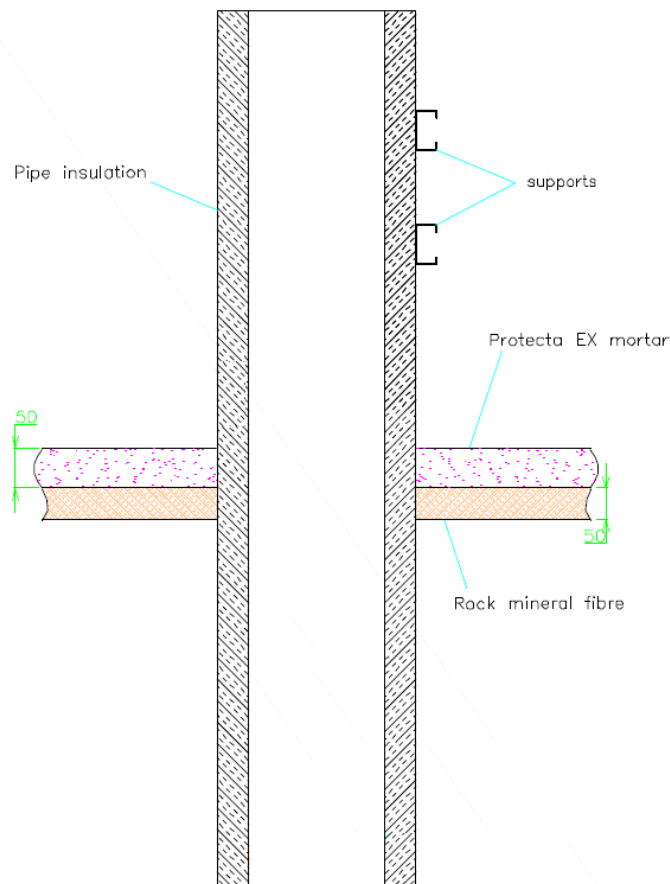
**Figure 6 Intermediate pipe wall thicknesses for typical mild or stainless steel pipe diameters**

### 6.4.3 Pipe penetration seal with 50 mm deep Protecta EX Mortar backed with mineral fibre board

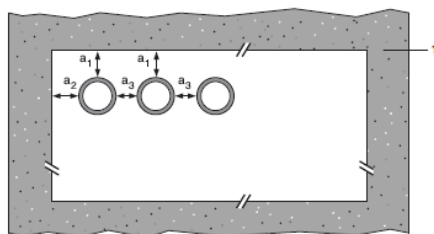
**Penetration seal:**

CS (Continuous Sustained) insulated metallic pipes fitted at any position within the aperture, with min. 50 mm Protecta EX Mortar, backed with min. 50 mm stone wool min. 150 kg/m<sup>3</sup> positioned at any height within the depth of the floor. Minimum separation between penetration seals and seal edges of 30 mm (configuration 1 & 2). Maximum aperture size as 4.1 4)

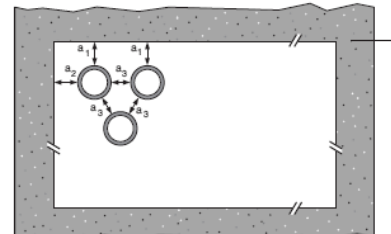
**Construction details:**



**Configuration 1**



**Configuration 2**

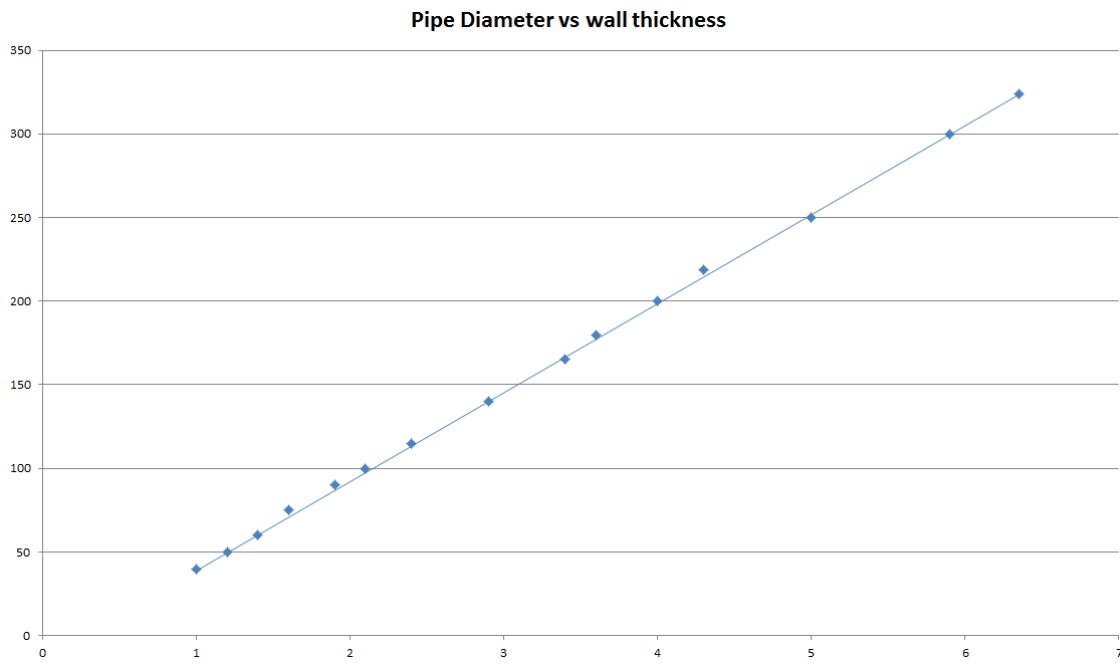


**Key**

- 1 Supporting construction
- a1 Pipe / top edge of seal separation
- a2 Pipe / side edge of seal separation
- a3 Pipe / pipe separation

**Table 23 Pipe penetration seal with 50 mm deep Protecta EX Mortar backed with mineral fibre board**

Services	Insulation	FRL
<b>Mild or stainless steel pipes</b>		
40 mm diameter/1-14.2 mm wall	20 mm thick stone, mineral wool min. 80 kg/m <sup>3</sup>	-/180/180 C/U (-240/240 C/U)*
40 mm diameter/1-14.2 mm wall*	30-80 mm thick stone, mineral wool min. 80 kg/m <sup>3</sup>	
50 mm diameter/1.2-14.2 mm wall*		
60 mm diameter/1.4-14.2 mm wall*		
75 mm diameter/1.6-14.2 mm wall*		
90 mm diameter/1.9-14.2 mm wall*		
100 mm diameter/2.1-14.2 mm wall*		
115 mm diameter/2.4-14.2 mm wall*		
140 mm diameter/2.9-14.2 mm wall*		
165 mm diameter/ 3.4-14.2 mm wall*		
180 mm diameter/ 3.6-14.2 mm wall*		
200 mm diameter/ 4.0-14.2 mm wall*		
219 mm diameter/ 4.3-14.2 mm wall*		
250 mm diameter/ 5.0-14.2 mm wall*		
300 mm diameter/ 5.9-14.2 mm wall*		
324 mm diameter/ 6.35-14.2 mm wall*		
<b>PEX pipe in pipe systems</b>		
15 mm diameter × 2.5 mm wall inner /25 mm diameter outer	None	-/180/180 C/C (-240/240 C/C)*
*-/240/240 in apertures up to a maximum of 550 mm × 1100 mm		



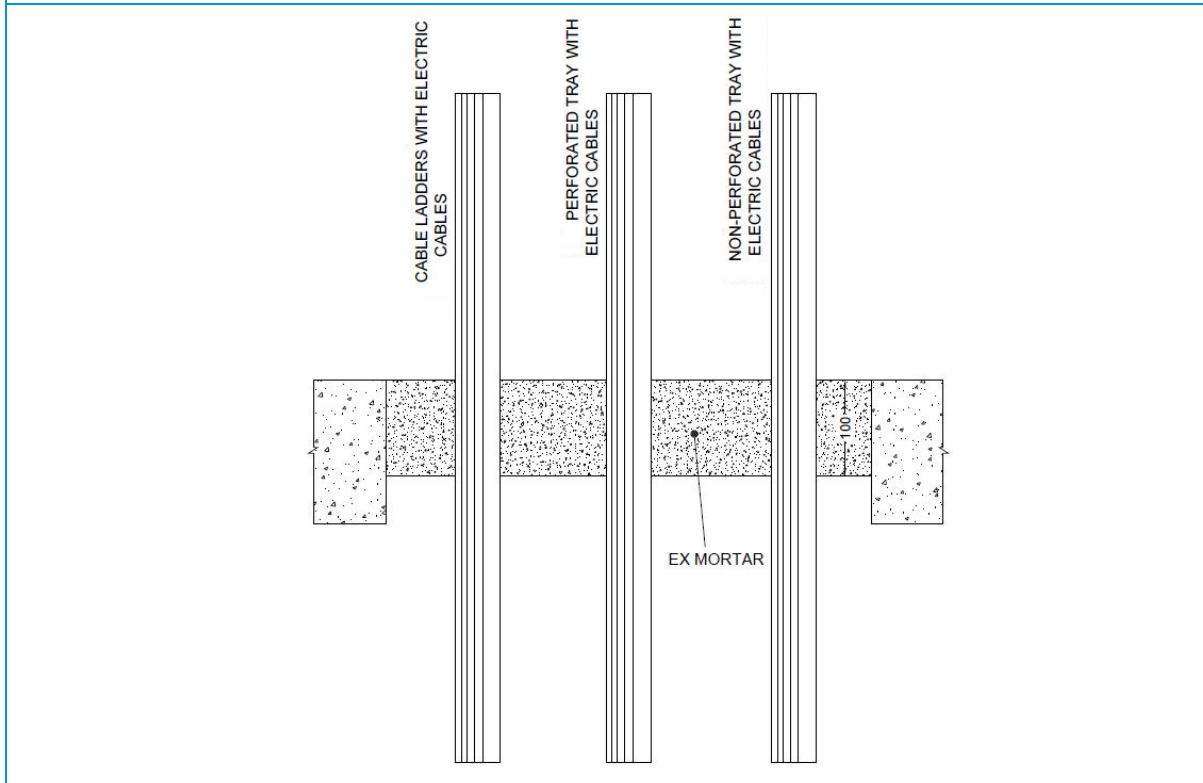
**Figure 7** Intermediate pipe wall thicknesses for typical mild or stainless steel pipe diameters

### 6.4.4 Cable penetration seal with 100 mm deep Protecta EX Mortar

**Penetration seal:**

Cables fitted at any position within the aperture (min. separation 30 mm from seal edges), with min. 100 mm Protecta EX Mortar flush with the top of the floor

**Construction details:**



**Table 24 Single side penetration seal with cables**

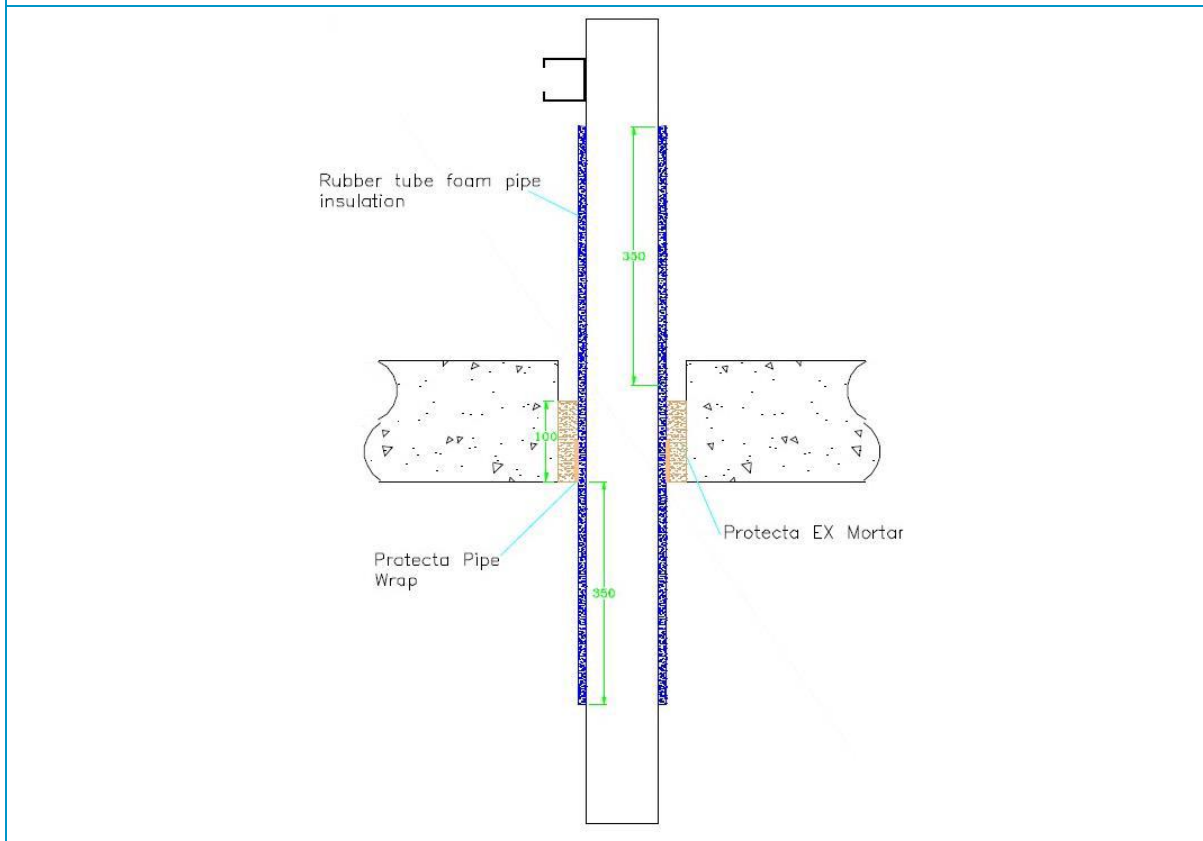
Services	Maximum aperture	FRL
None (blank)	As section 4.1 4)	-/240/240
Electrical cables up to Ø 50 mm (single, bundled and on trays)		-/180/60
Electrical cables up to Ø 80 mm (single, bundled and on trays)		-/120/60
Cables up to Ø 21 mm in tied bundles up to 100 mm		-/180/120
Steel cable trays & ladders		-/120/60
Non-sheathed cables up to Ø 17 mm		-/180/90
Non-sheathed cables up to Ø 24 mm		-/180/15
PVC conduits up to Ø 16 mm		-/180/180 C/U, C/C

### 6.4.5 Pipe penetration seal with 100 mm deep Protecta EX Mortar

**Penetration seal:**

CS (Continuous Sustained) insulated metallic pipes fitted at any position within the aperture (min. separation 25 mm from seal edges and 30 mm from other services), with min. 100 mm Protecta EX Mortar at any position within the floor. Protecta FR Pipes Wraps are required to be fitted around combustible pipe insulation. Maximum seal size as section 4.1 4)

**Construction details:**



**Table 25 Single side penetration seal with pipes**

Services	Wrap	Insulation	FRL
<b>Copper and steel pipes</b>			
12 mm diameter/1 mm wall	50 mm × 3.6 mm Protecta FR Pipe Wrap fitted to the soffit	9 mm Elastomeric insulation minimum class B-s3,d0 or foil faced Phenolic Foam insulation	-/240/240 C/C
12-54 mm diameter/1-1.2 mm wall		13-25 mm Elastomeric insulation minimum class B-s3,d0 or foil faced Phenolic Foam insulation	-/240/60 C/C
<b>Alupex pipes</b>			
16 mm diameter/2.25 mm wall	50 mm × 3.6 mm Protecta FR Pipe Wrap fitted to the soffit	9 mm Elastomeric insulation minimum class B-s3,d0 or foil faced Phenolic Foam insulation	-/240/240 C/C

Services	Wrap	Insulation	FRL
16 mm diameter/2.25 mm wall		9-13 mm Elastomeric insulation minimum class B-s3,d0 or foil faced Phenolic Foam insulation	-/240/90 C/C
20 mm diameter/2.5 mm wall			
26 mm diameter/3 mm wall			
32 mm diameter/3 mm wall			
40 mm diameter/3.5 mm wall			
50 mm diameter/4 mm wall			
63 mm diameter/4.5 mm wall			
75 mm diameter/4.7 mm wall			
16 mm diameter/2.25 mm wall		13-25 mm Elastomeric insulation minimum class B-s3,d0 or foil faced Phenolic Foam insulation	-/180/90 C/C
20 mm diameter/2.5 mm wall			
26 mm diameter/3 mm wall			
32 mm diameter/3 mm wall			
40 mm diameter/3.5 mm wall			
50 mm diameter/4 mm wall			
63 mm diameter/4.5 mm wall			
75 mm diameter/4.7 mm wall			

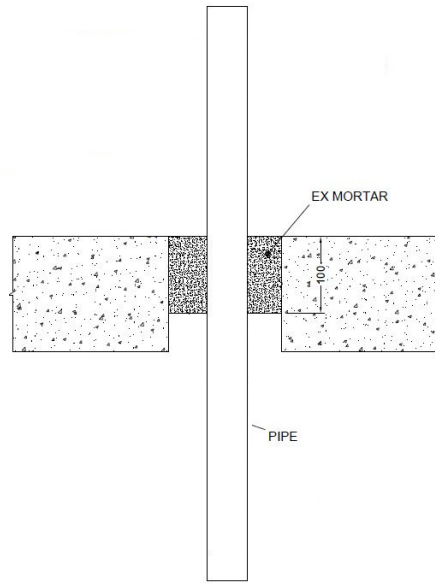
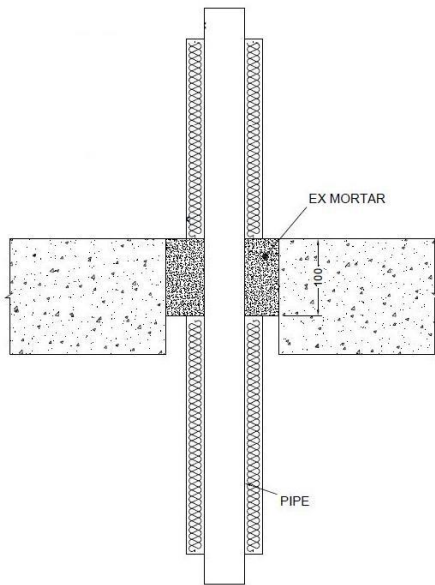


### 6.4.6 Pipe penetration seal with Protecta EX Mortar

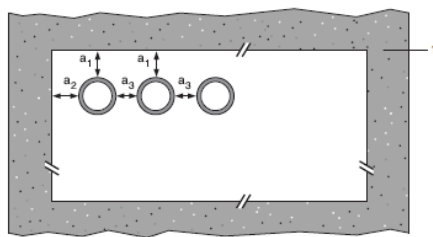
**Penetration seal:**

1000 mm (min.)\* LI (Local Interrupted) or CI (Continuous Interrupted) insulated and non-insulated metallic and composite pipes fitted at any position within the aperture (min. separation 30 mm from seal edges), with Protecta EX Mortar to either surface of the floor or anywhere between. Maximum seal size as section 4.1 4).

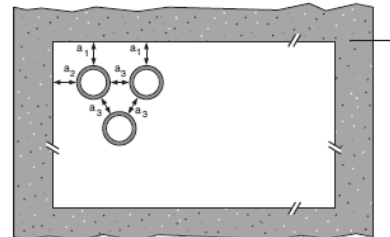
**Construction details:**



**Configuration 1**



**Configuration 2**



**Key**

- 1 Supporting construction
- a1 Pipe / top edge of seal separation
- a2 Pipe / side edge of seal separation
- a3 Pipe / pipe separation

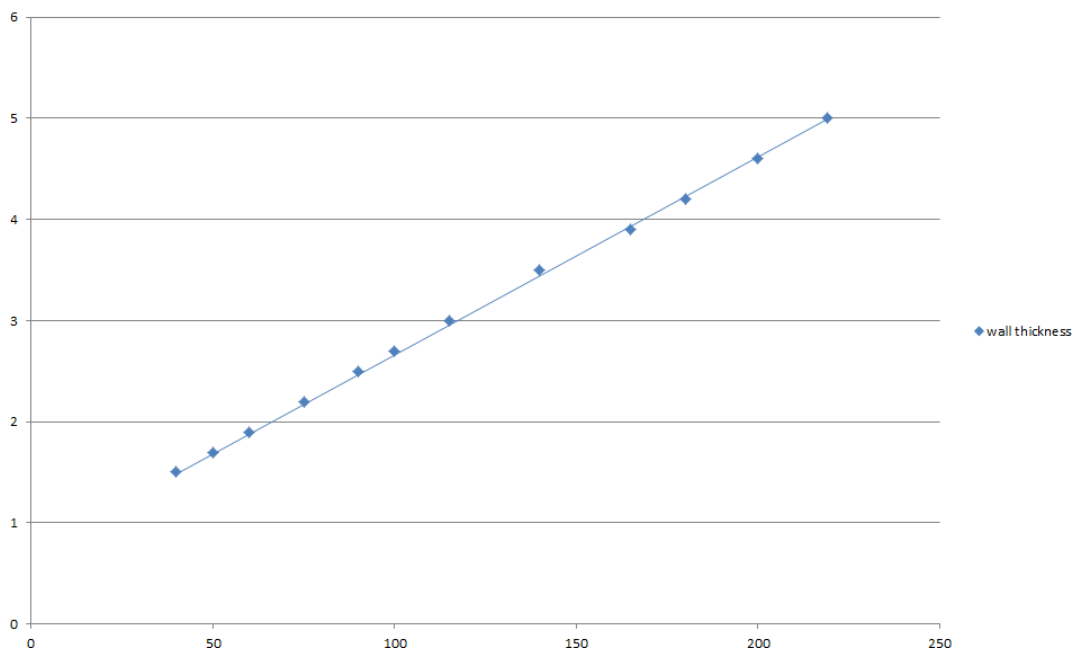
**Table 26 Single side penetration seal with pipes**

Services	Minimum mortar depth and floor thickness	Insulation	FRL
Up to 16 mm diameter steel pipes 1.5- 7 mm wall	100 mm	None	-/240/120 C/C
Up to 63.5 mm diameter steel pipes 1.6-14.2 mm wall	150 mm		-/180/90 C/U
Up to 12 mm diameter Copper and steel pipes 0.7-1.5 mm wall	120 mm		-/240/180 C/C
Up to 54 mm diameter Copper and steel pipes 1.5-14.2 mm wall	100 mm		-/120/- C/C
75 mm Alupex composite pipes with 4.6 mm wall	100 mm	None	-/240/- C/C

**Table 27 Single side penetration seal with pipes**

Services	Minimum mortar depth and floor thickness	Insulation, minimum thickness and density	FRL
<b>Mild or stainless steel pipes</b>			
40 mm diameter/1.5-14.2 mm wall*	100 mm	20 mm Stone wool insulation 80 kg/m <sup>3</sup>	-/240/240 C/U
40 mm diameter/1.5-14.2 mm wall*		30 mm Stone wool insulation 80 kg/m <sup>3</sup>	-/240/120 C/U
50 mm diameter/1.7-14.2 mm wall*			
60 mm diameter/1.8-14.2 mm wall*			
75 mm diameter/2.1-14.2 mm wall*			
90 mm diameter/2.3-14.2 mm wall*			
100 mm diameter/2.5-14.2 mm wall*			
115 mm diameter/2.8-14.2 mm wall*			
140 mm diameter/3.2-14.2 mm wall*			
165 mm diameter/ 3.6-14.2 mm wall*			
180 mm diameter/ 3.9-14.2 mm wall*			
200 mm diameter/ 4.2-14.2 mm wall*			
219 mm diameter/ 4.5-14.2 mm wall*			
*Typical pipe diameters shown, see below graph for intermediate sizes			

**Pipe diameter vs Wall thickness**



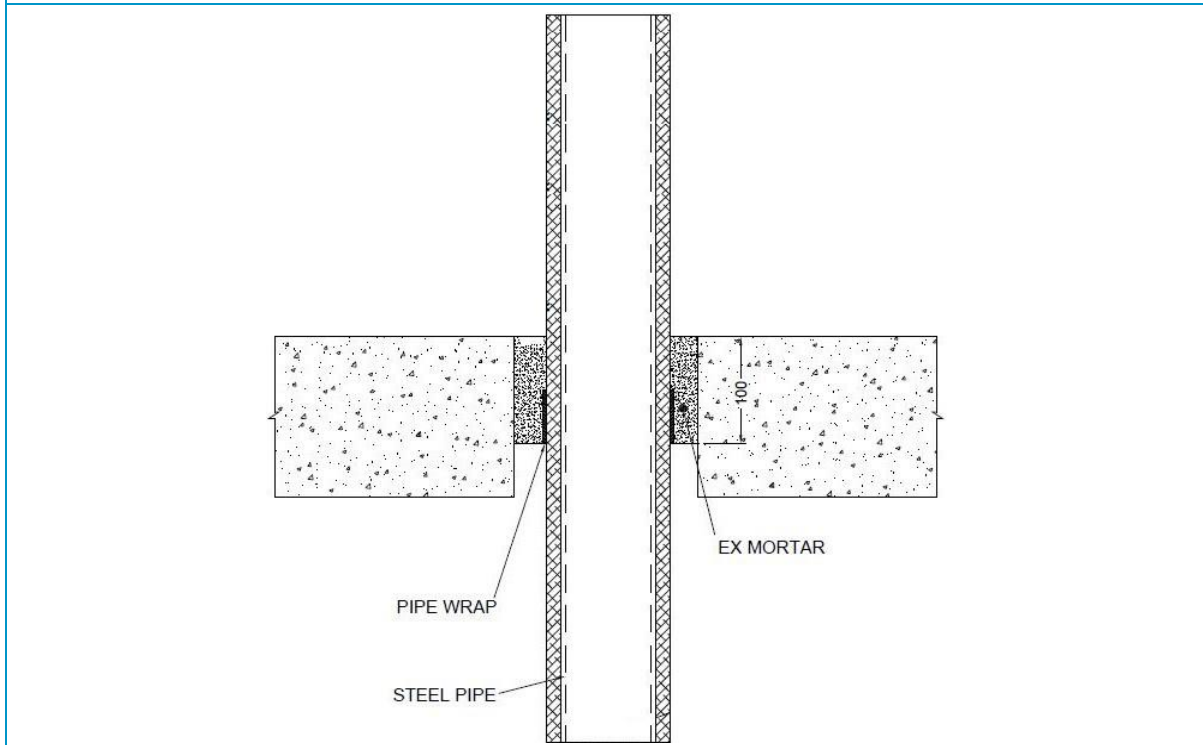
**Figure 8 Intermediate pipe wall thicknesses for typical mild or stainless steel pipe diameters**

### 6.4.7 Pipe penetration seal with 100 mm deep Protecta EX Mortar

**Penetration seal:**

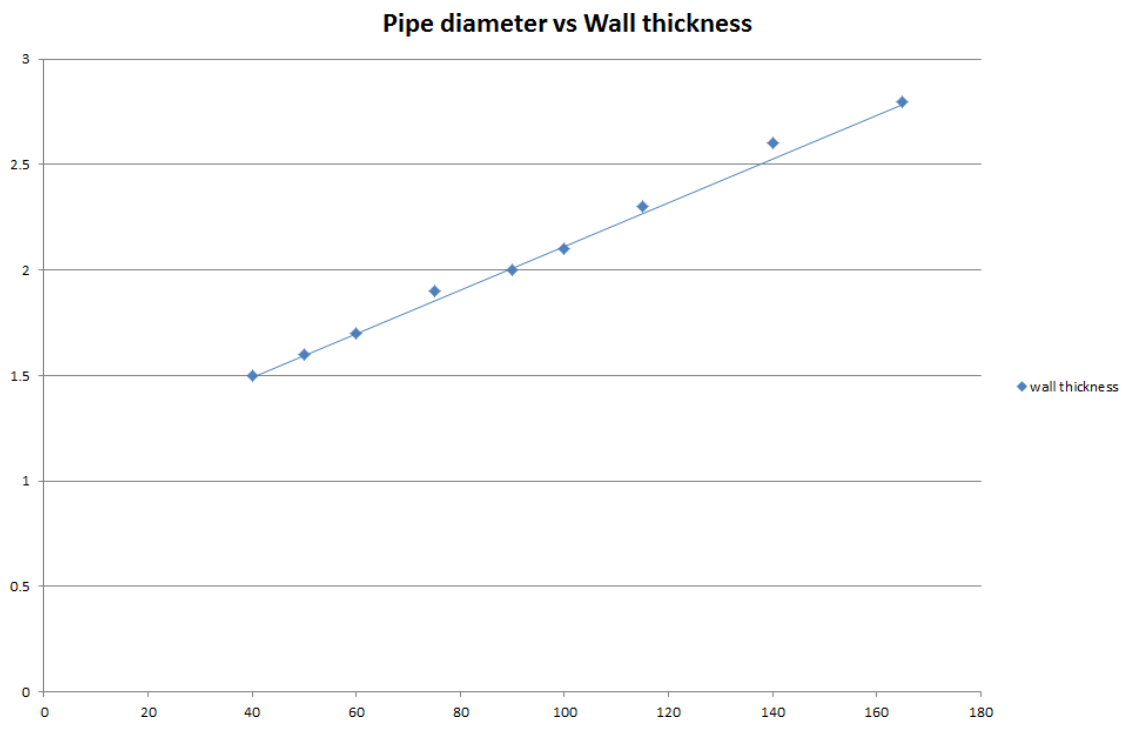
CS (Continuous Sustained) insulated metallic pipes fitted at any position within the aperture (min. separation 30 mm from seal edges and 30 mm from other services), with min. 100 mm Protecta EX Mortar to the top surface of the floor. Protecta FR Pipes Wraps are required to be fitted around combustible pipe insulation. Maximum seal size as section 4.1 4).

**Construction details:**



**Table 28 Single side penetration seal with pipes**

Services	Wrap	Insulation	FRL
<b>Mild or stainless steel pipes</b>			
40 mm diameter/1.5-14.2 mm wall	1 off 50 mm × 1.8 mm Protecta FR Pipe Wrap, fitted at soffit	13 mm Elastomeric insulation minimum class B-s3,d0 or foil faced Phenolic Foam insulation	-/180/180 C/U
40 mm diameter/1.5-14.2 mm wall*			
50 mm diameter/1.6-14.2 mm wall*			
60 mm diameter/1.7-14.2 mm wall*			
75 mm diameter/1.9-14.2 mm wall*			
90 mm diameter/2-14.2 mm wall*			
100 mm diameter/2.1-14.2 mm wall*			
115 mm diameter/2.3-14.2 mm wall*			
140 mm diameter/2.6-14.2 mm wall*			
165 mm diameter/2.8-14.2 mm wall*		13 -19 mm Elastomeric insulation minimum class B-s3,d0 or foil faced Phenolic Foam insulation	-/180/120 C/U
*Typical pipe diameters shown, see below graph for intermediate sizes			



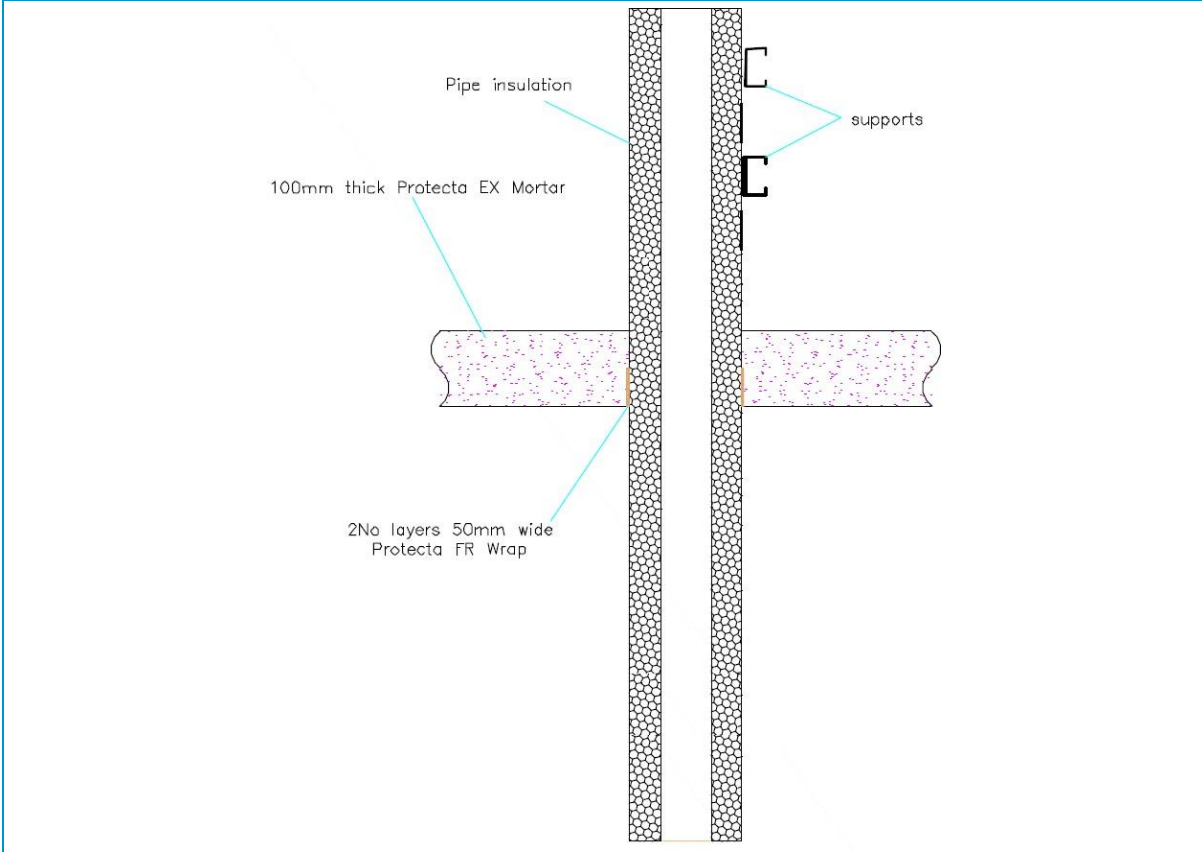
**Figure 9** Intermediate pipe wall thicknesses for typical mild or stainless steel pipe diameters

### 6.4.8 Pipe penetration seal with 100 mm deep Protecta EX Mortar

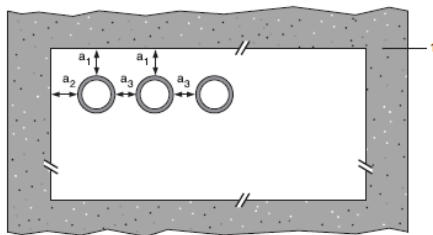
**Penetration seal:**

CS (Continuous Sustained) insulated metallic pipes sealed with Protect FR wraps, fitted at any position within the aperture, with min. 100 mm Protecta EX Mortar Seal. Minimum separation between penetration seals and seal edges of 30 mm (Configuration 1 & 2). Maximum seal size as section 4.1 4).

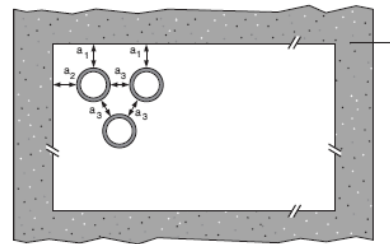
**Construction details:**



**Configuration 1**



**Configuration 2**

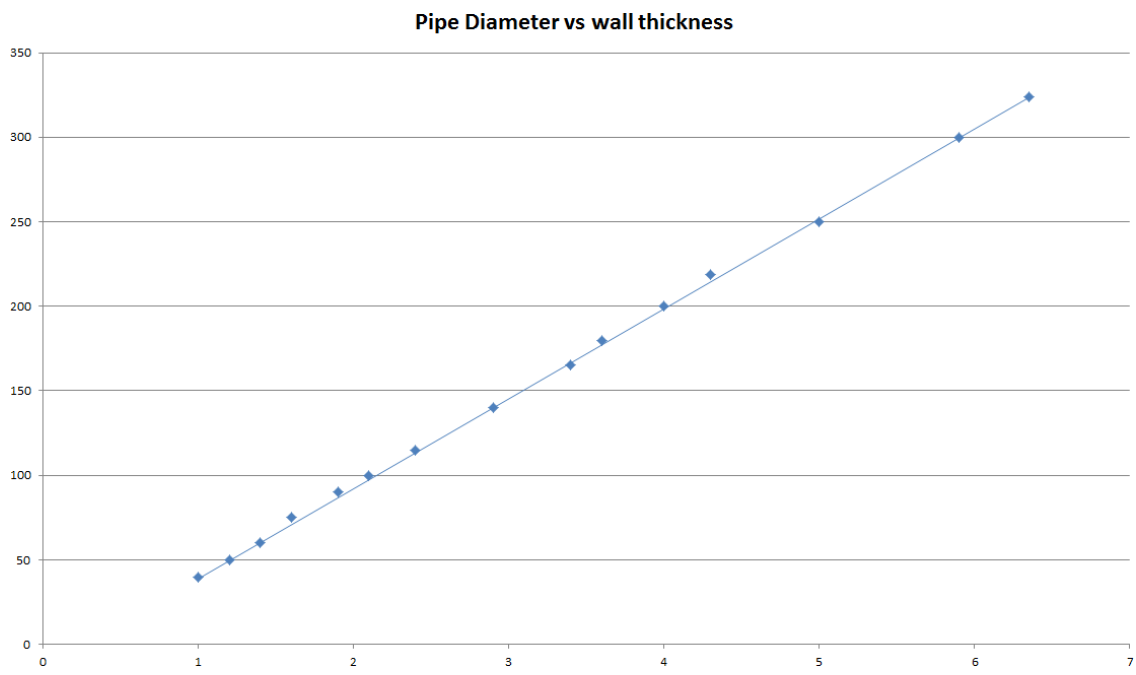


**Key**

- 1 Supporting construction
- a1 Pipe / top edge of seal separation
- a2 Pipe / side edge of seal separation
- a3 Pipe / pipe separation

**Table 29 Pipe penetration seal with 100 mm deep Protecta EX Mortar**

Services	Insulation	Protecta FR Wrap	FRL
40 mm diameter/1-14.2 mm wall	25 mm thick Elastomeric insulation minimum class B- s3,d0 or foil faced Phenolic Foam insulation	50 mm × 3.6 mm (2 x 1.8 mm layers)	-/240/240 C/U
40 mm diameter/1-14.2 mm wall*	25mm thick Elastomeric insulation minimum class B- s3,d0 or foil faced Phenolic Foam insulation		240/120 C/U
50 mm diameter/1.2-14.2 mm wall*			
60 mm diameter/1.4-14.2 mm wall*			
75 mm diameter/1.6-14.2 mm wall*			
90 mm diameter/1.9-14.2 mm wall*			
100 mm diameter/2.1-14.2 mm wall*			
115 mm diameter/2.4-14.2 mm wall*			
140 mm diameter/2.9-14.2 mm wall*			
165 mm diameter/ 3.4-14.2 mm wall*			
180 mm diameter/ 3.6-14.2 mm wall*			
200 mm diameter/ 4.0-14.2 mm wall*			
219 mm diameter/ 4.3-14.2 mm wall*			
250 mm diameter/ 5.0-14.2 mm wall*			
300 mm diameter/ 5.9-14.2 mm wall*			
324 mm diameter/ 6.35-14.2 mm wall*			
40 mm diameter/1-14.2 mm wall*	25-50mm thick Elastomeric insulation minimum class B- s3,d0 or foil faced Phenolic Foam insulation	50 mm × 5.4 mm (3 × 1.8 mm layers)	-/120/120 C/U
50 mm diameter/1.2-14.2 mm wall*			
60 mm diameter/1.4-14.2 mm wall*			
75 mm diameter/1.6-14.2 mm wall*			
90 mm diameter/1.9-14.2 mm wall*			
100 mm diameter/2.1-14.2 mm wall*			
115 mm diameter/2.4-14.2 mm wall*			
140 mm diameter/2.9-14.2 mm wall*			
165 mm diameter/ 3.4-14.2 mm wall*			
180 mm diameter/ 3.6-14.2 mm wall*			
200 mm diameter/ 4.0-14.2 mm wall*			
219 mm diameter/ 4.3-14.2 mm wall*			
250 mm diameter/ 5.0-14.2 mm wall*			
300 mm diameter/ 5.9-14.2 mm wall*			
324 mm diameter/ 6.35-14.2 mm wall*			



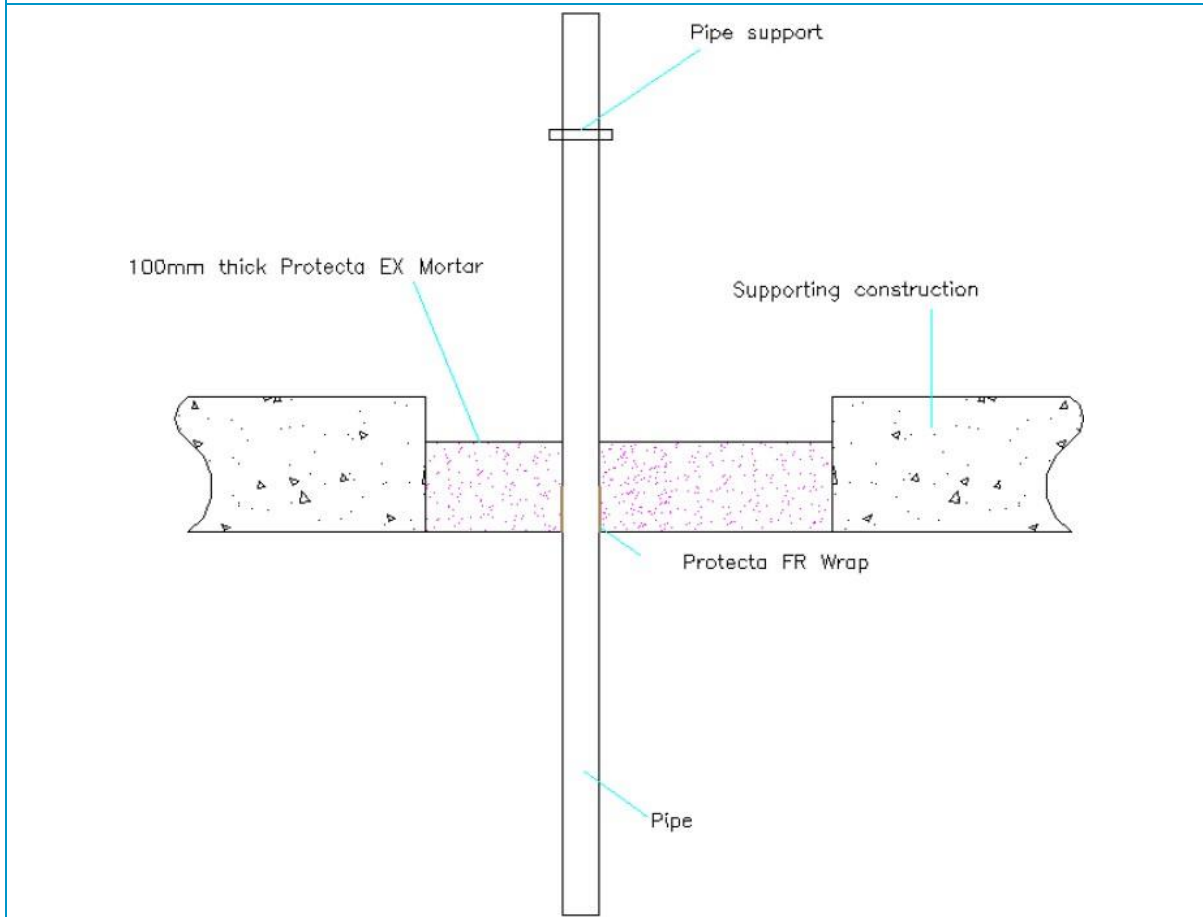
**Figure 10** Intermediate pipe wall thicknesses for typical mild or stainless steel pipe diameters

### 6.4.9 Pipe penetration seal with 100 mm deep Protecta EX Mortar

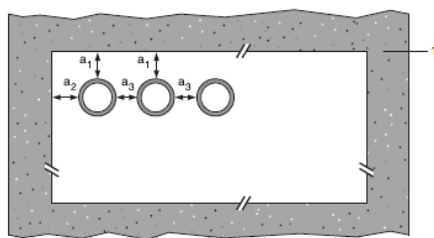
**Penetration seal:**

Plastic pipes fitted at any position within the aperture, with min. 100 mm Protecta EX Mortar to the either surface of the floor or anywhere between. Protecta FR Pipe wraps are required to be fitted to the bottom of the seal, as indicated below. Minimum separation between penetration seals and seal edges of 30 mm (Configuration 1 & 2).

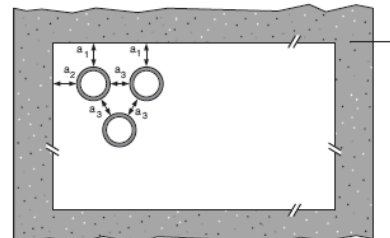
**Construction details:**



**Configuration 1**



**Configuration 2**



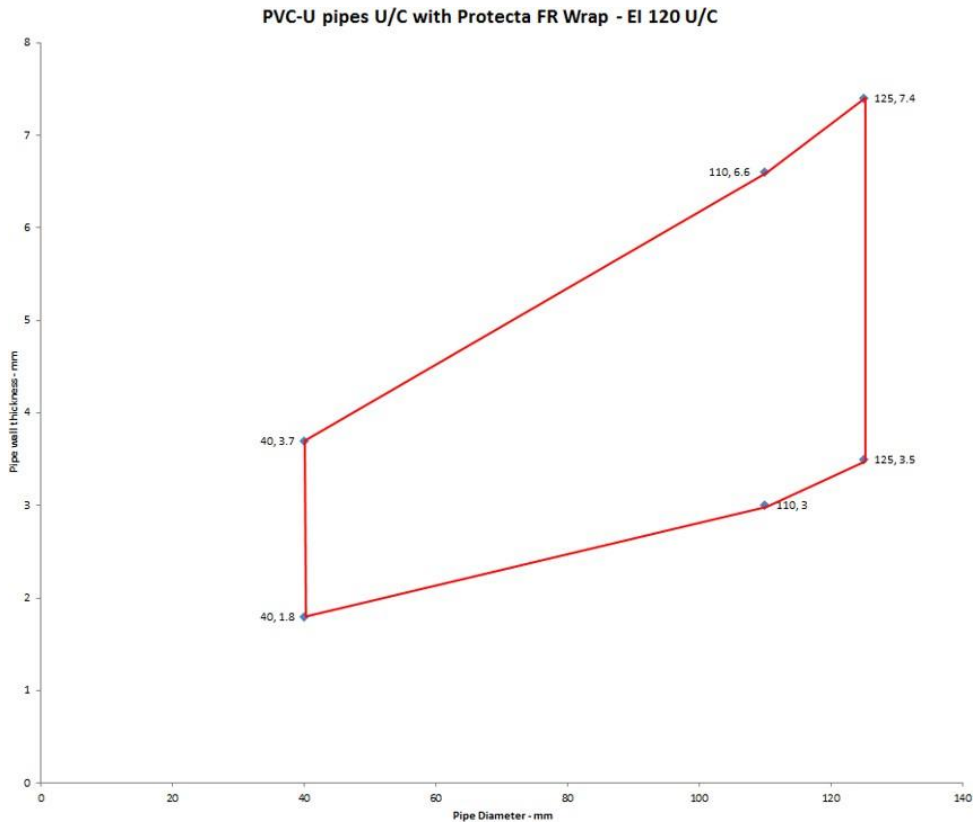
**Key**

- 1 Supporting construction
- a1 Pipe / top edge of seal separation
- a2 Pipe / side edge of seal separation
- a3 Pipe / pipe separation

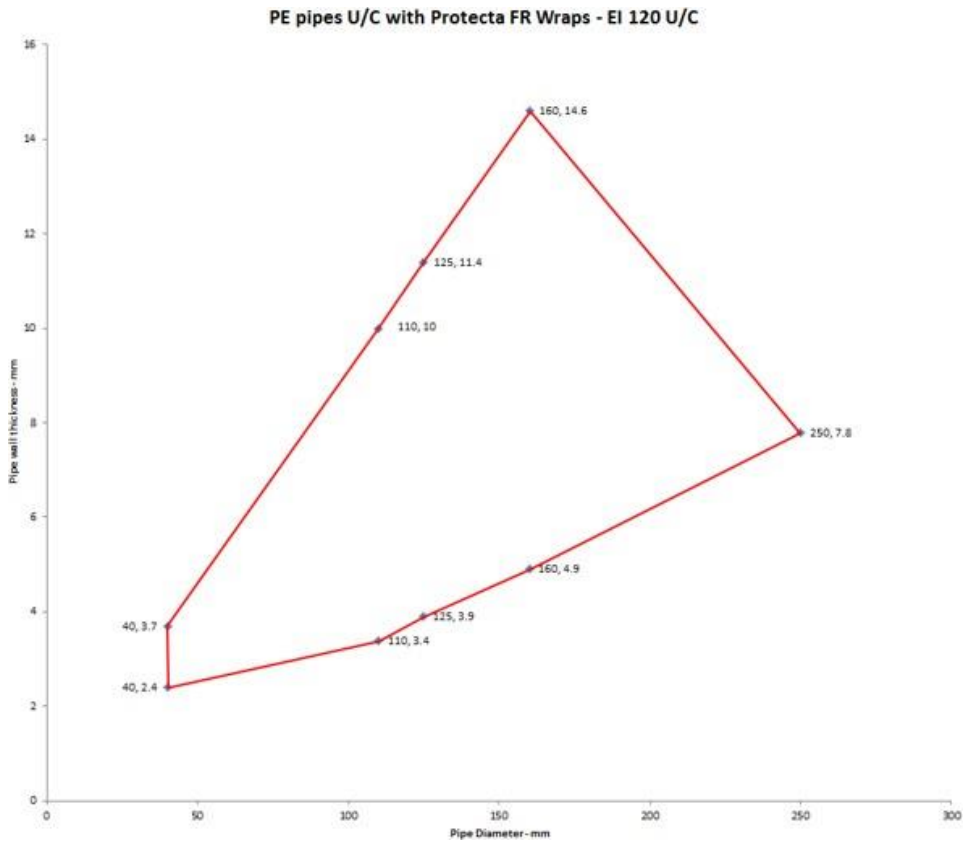


**Table 30 Single side penetration seal with pipes**

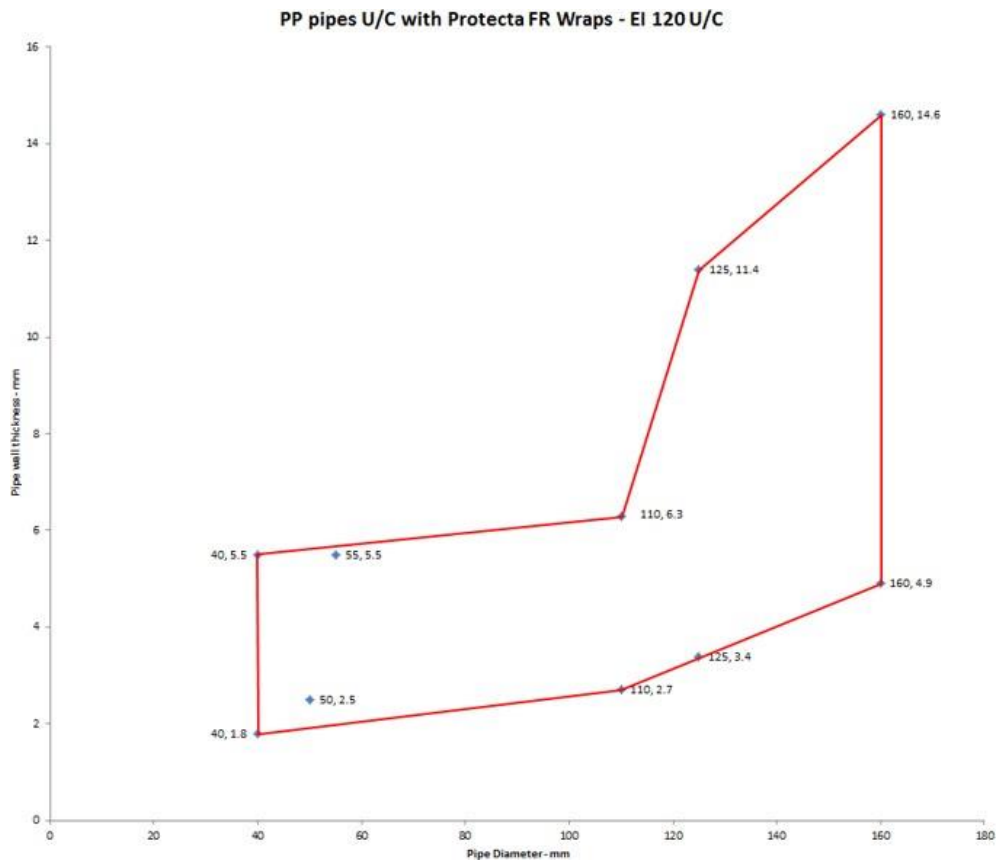
Services	Wrap	Maximum aperture	FRL
<b>PVC-U pipes</b>			
Up to 40 mm diameter / 1.8-3.7 mm wall	50 mm × 1.8 mm	As section 4.1 4)	-/180/120 U/U
Up to 110 mm diameter / 3.0-6.6 mm wall	50 mm × 3.6 mm		-/240/240 U/C
Up to 125 mm diameter / 3.5-7.4 mm wall	50 mm × 7.2 mm		-/120/120 U/C
Up to 160 mm diameter / 4.5 mm wall	50 mm × 10.8 mm		-/240/240 C/C
Up to 160 mm diameter / 4.5-9.5 mm wall	50 mm × 10.8 mm		-/90/90 C/C
Up to 110 mm diameter/ 2.7-6.6 mm wall, containing up to Ø 90 mm bundle of up to Ø 14 mm cables	50 mm × 3.6 mm		-/120/120 U/C
<b>PP pipes</b>			
Up to 40 mm diameter /1.8-4.4 mm wall	None	As section 4.1 4)	-/120/120 U/C
Up to 40 mm diameter /1.8-5.5 mm wall	50 mm × 1.8 mm		-/120/120 U/U
Up to 50 mm diameter /2.5-5.5 mm wall	50 mm × 3.6 mm		-/240/240 C/C
Up to 75 mm diameter /3.5-5.5 mm wall	50 mm × 3.6 mm		-/240/240 C/C
Up to 110 mm diameter /2.7-6.3 mm wall	50 mm × 3.6 mm		-/240/240 U/C
Up to 125 mm diameter /3.4-11.4 mm wall	50 mm × 7.2 mm		-/240/240 U/C
Up to 160 mm diameter /4.9-14.6 mm wall	50 mm × 10.8 mm		-/240/240 U/C
Up to 110 mm diameter/ 3.4-6.3 mm wall, containing up to Ø 90 mm bundle of up to Ø 14 mm cables	50 mm × 3.6 mm		-/60/60 U/C
<b>PE pipes</b>			
Up to 40 mm diameter / 2.0-4.4 mm wall	None	As section 4.1 4)	-/120/120 U/C
Up to 40 mm diameter / 2.4-3.7 mm wall	50 mm × 1.8 mm		-/240/240 U/U
Up to 110 mm diameter / 3.4-10.0 mm wall	50 mm × 3.6 mm		-/120/120 U/C
Up to 125 mm diameter / 3.9-11.4 mm wall	50 mm × 7.2 mm		-/240/240 U/C
Up to 160 mm diameter / 4.9-14.6 mm wall	50 mm × 10.8 mm		-/120/120 U/C
Up to 250 mm diameter / 7.8 mm wall	75 mm × 12.6 mm		-/180/180 C/C
Up to 110 mm diameter/ 2.7-10.0 mm wall, containing up to Ø 90 mm bundle of up to Ø 14 mm cables	50 mm × 3.6 mm		-/120/60 U/C



**Figure 11** Intermediate pipe wall thicknesses for typical PVC-U pipe diameters with Protecta FR Wrap



**Figure 12** Intermediate pipe wall thicknesses for typical PE pipe diameters with Protecta FR Wrap



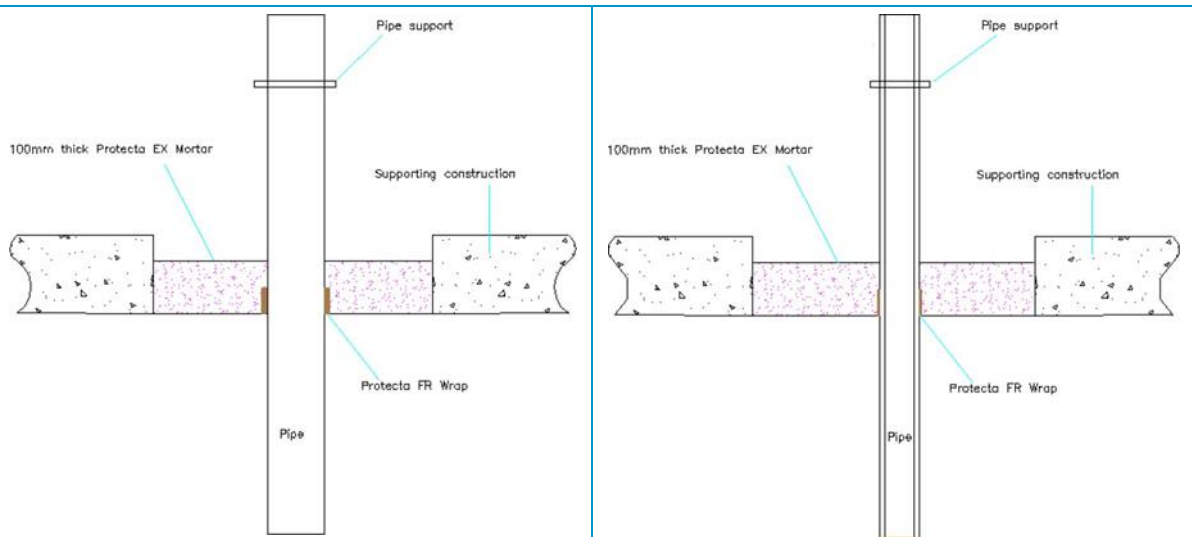
**Figure 13** Intermediate pipe wall thicknesses for typical PP pipe diameters with Protecta FR Wrap

### 6.4.10 Pipe penetration seal with 100 mm deep Protecta EX Mortar

**Penetration seal:**

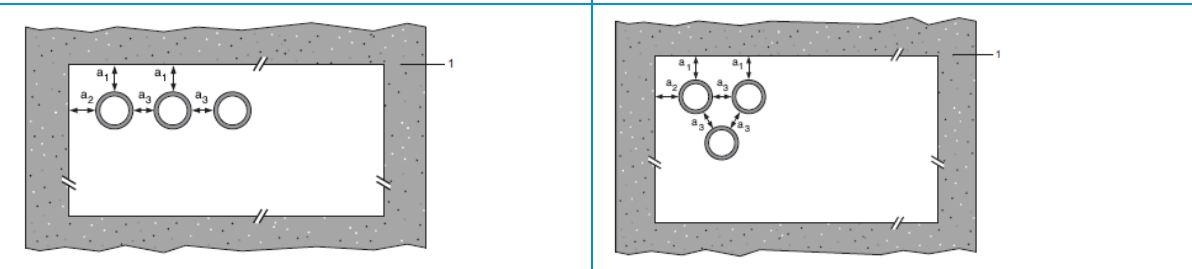
Plastic pipes fitted at any position within the aperture (min. separation 30 mm from seal edges and from other services), with min. 100 mm Protecta EX Mortar to either surface of the floor or anywhere between. Protecta FR Pipe Wraps are required to be fitted to the bottom of the seal, as indicated below. Maximum seal size as section 4.1 4).

**Construction details:**



**Configuration 1**

**Configuration 2**



**Key**

- 1 Supporting construction
- a1 Pipe / top edge of seal separation
- a2 Pipe / side edge of seal separation
- a3 Pipe / pipe separation

**Table 31 Pipe penetration seal with 100 mm deep Protecta EX Mortar**

Services	Wrap	Permitted configuration for seal separation	FRL
<b>PVC-U pipes</b>			
160 mm diameter / 9.5 mm wall	50 mm × 10.8 mm (6 × 1.8 mm layers)	1 & 2	-/90/90 U/C
<b>PEX pipe in pipe systems</b>			
Maximum 54 mm diameter/0.4 mm wall thickness (outer pipe), 28 mm diameter/4.0 mm wall thickness (inner pipe)	50 mm × 3.6 mm (2 × 1.8 mm layers)	1 & 2	-/120/120 C/C
<b>Rehau Raupiano Plus PP-DD</b>			

Services	Wrap	Permitted configuration for seal separation	FRL
40-50 mm diameter/1.8-2.7 mm wall thickness*	50 mm × 3.6 mm (2 × 1.8 mm layers)	1 & 2	-/120/120 U/U
75-110 mm diameter/2.7 mm wall thickness*	50 mm × 3.6 mm (2 × 1.8 mm layers)	1 & 2	-/120/120 U/C
125 mm diameter/3.1 mm wall thickness	50 mm × 7.2 mm (4 × 1.8 mm layers)	1 & 2	-/240/120 U/C
160 mm diameter/3.9 mm wall thickness	50 mm × 10.8 mm (6 × 1.8 mm layers)	1 & 2	-/120/120 U/C
<b>Polo-Kal NG Poloplast PP-MV</b>			
32-110 mm diameter/3.4 mm wall thickness	50 mm × 3.6 mm (2 × 1.8 mm layers)	1 & 2	-/180/180 U/C
125 mm diameter/3.9 mm wall thickness	50 mm × 7.2 mm (4 × 1.8 mm layers)	1 & 2	-/240/240 U/C
160 mm diameter/4.3 mm wall thickness	50 mm × 10.8 mm (6 × 1.8 mm layers)	1 & 2	-/240/240 U/C
<b>Aquatherm Green SDR9 MF PP-RP</b>			
32 mm diameter/3.6 mm wall thickness	50 mm × 1.8 mm (1 × 1.8 mm layers)	1 & 2	-/240/240 C/C
40-50 mm diameter/5.6-12.3 mm wall thickness*	50 mm × 3.6 mm (2 × 1.8 mm layers)	1 & 2	-/240/240 C/C
63-110 mm diameter/12.3 mm wall thickness*	50 mm × 3.6 mm (2 × 1.8 mm layers)	1 & 2	-/240/240 C/C
<b>Wavin SiTech + PP-M B</b>			
32-50 mm diameter/1.8-3.4 mm wall thickness*	50 mm × 3.6 mm (2 × 1.8 mm layers)	1 & 2	-/120/120 U/U
75-110 mm diameter/3.4 mm wall thickness*	50 mm × 3.6 mm (2 × 1.8 mm layers)	1 & 2	-/120/120 U/C
<b>Gilbert Silent PP</b>			
32-50 mm diameter/1.8-3.4 mm wall thickness*	50 mm × 3.6 mm (2 × 1.8 mm layers)	1 & 2	-/120/120U/U
75-110 mm diameter/3.4 mm wall thickness*	50 mm × 3.6 mm (2 × 1.8 mm layers)	1 & 2	-/120/120 U/C
<b>Blue Power Multilayer pipes</b>			
32-50 mm diameter*	50 mm × 3.6 mm (2 × 1.8 mm layers)	1 & 2	-/240/240 U/U
75-110 mm diameter*	50 mm × 3.6 mm (2 × 1.8 mm layers)	1 & 2	-/120/120 U/C
125 mm diameter/3.9 mm wall thickness*	50 mm × 7.2 mm (4 × 1.8 mm layers)	1 & 2	-/120/120 U/C
160 mm diameter/4.9 mm wall thickness*	50 mm × 10.8 mm (6 × 1.8 mm layers)	1 & 2	-/240/240 U/C
<b>Uponor Decibel pipes</b>			

Services	Wrap	Permitted configuration for seal separation	FRL
32-50 mm diameter*	50 mm × 3.6 mm (2 × 1.8 mm layers)	1 & 2	-/120/120 U/U
75-110 mm diameter*	50 mm × 3.6 mm (2 × 1.8 mm layers)	1 & 2	-/120/120 U/C

\*Typical pipe diameters shown, see below graph for intermediate sizes

Rehau Raupiano Plus -EI 120 U/U

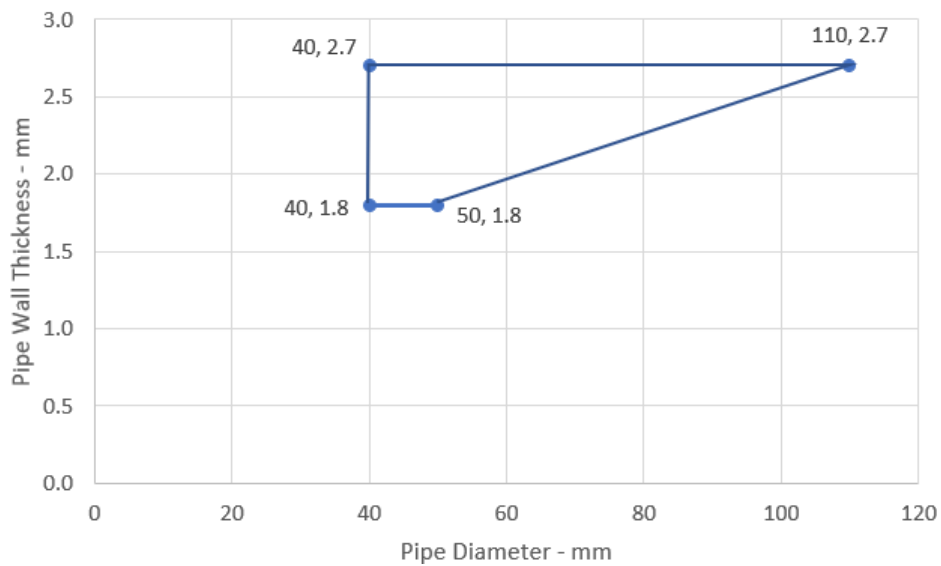


Figure 14 Intermediate pipe wall thicknesses for Rehau Raupiano Plus pipe diameters

Aquatherm Green - EI 240 C/C

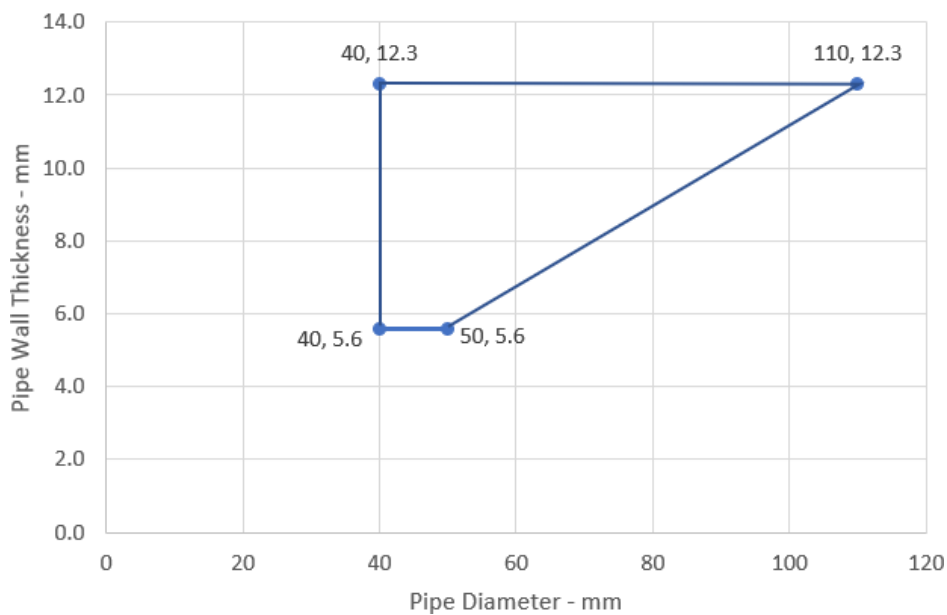


Figure 15 Intermediate pipe wall thicknesses for Aquatherm Green pipe diameters

Wavin SiTech Pipes - EI 120 U/C

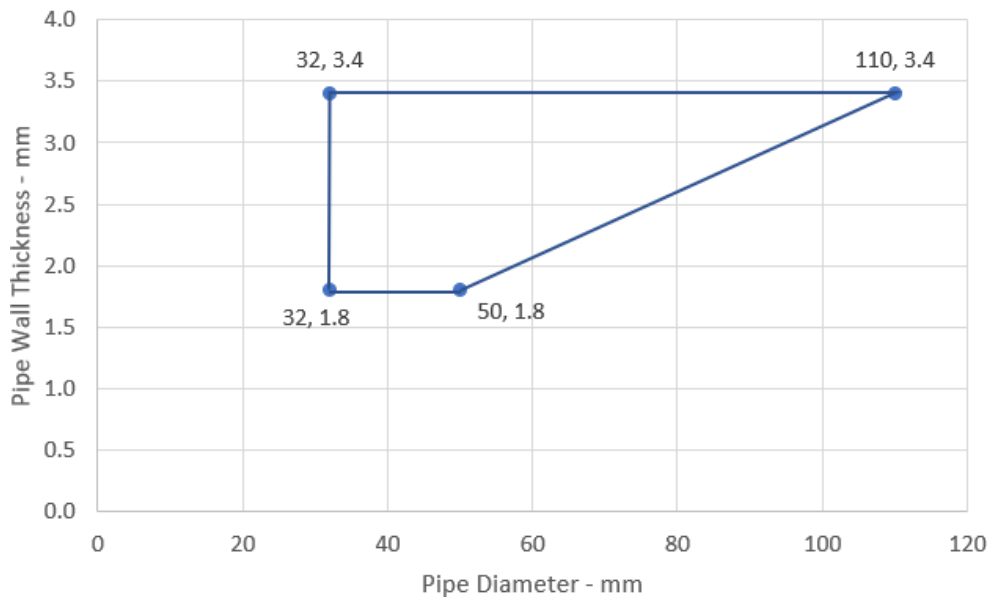


Figure 16 Intermediate pipe wall thicknesses for Wavin SiTech pipe diameters

Gilbert Silent PP - EI 120 U/C

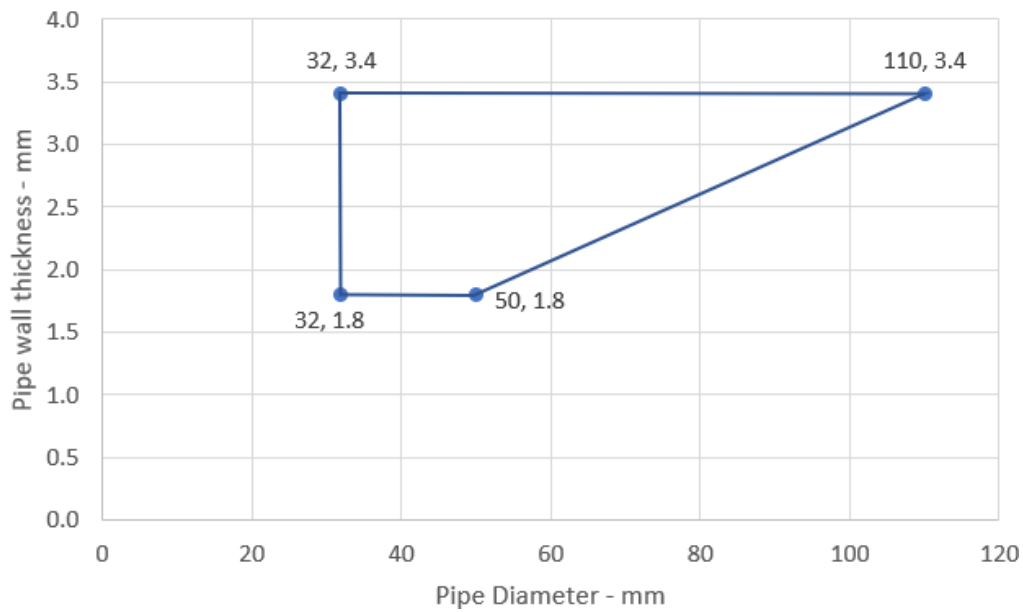
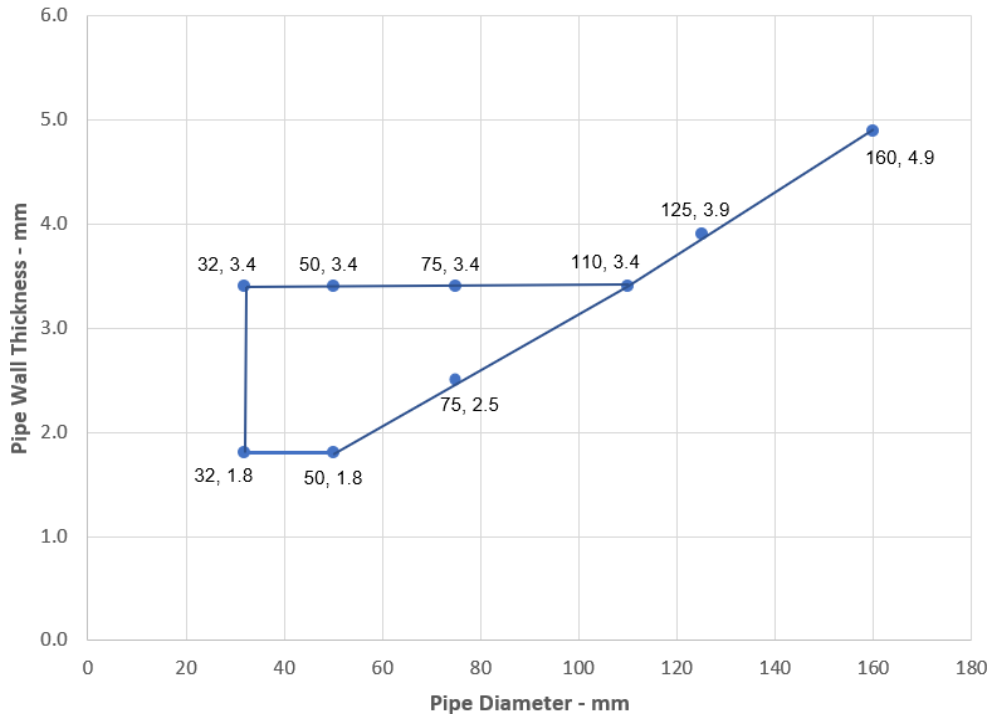


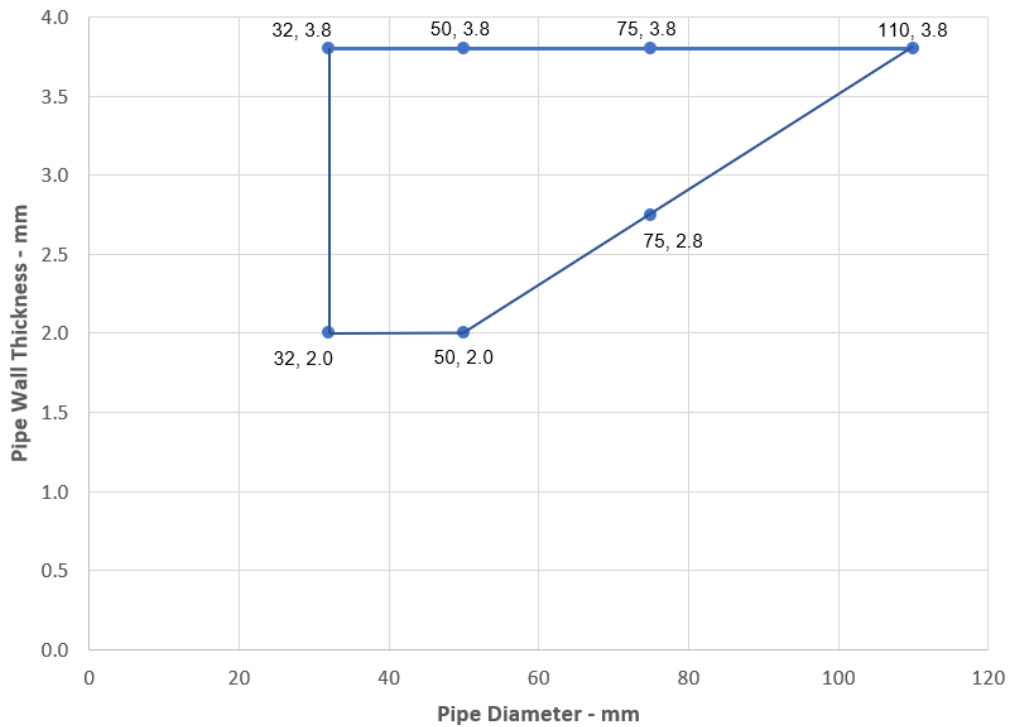
Figure 17 Intermediate pipe wall thicknesses for Gilbert Silent PP pipe diameters

**BluePower Pipes 32-110 / 50 mm Wrap - U/C**



**Figure 18 Intermediate pipe wall thicknesses for BluePower pipe diameters**

**Uponor Decibel Pipes 32-110 / 50 mm Wrap - U/C**



**Figure 19 Intermediate pipe wall thicknesses for Uponor Decibel pipe diameters**

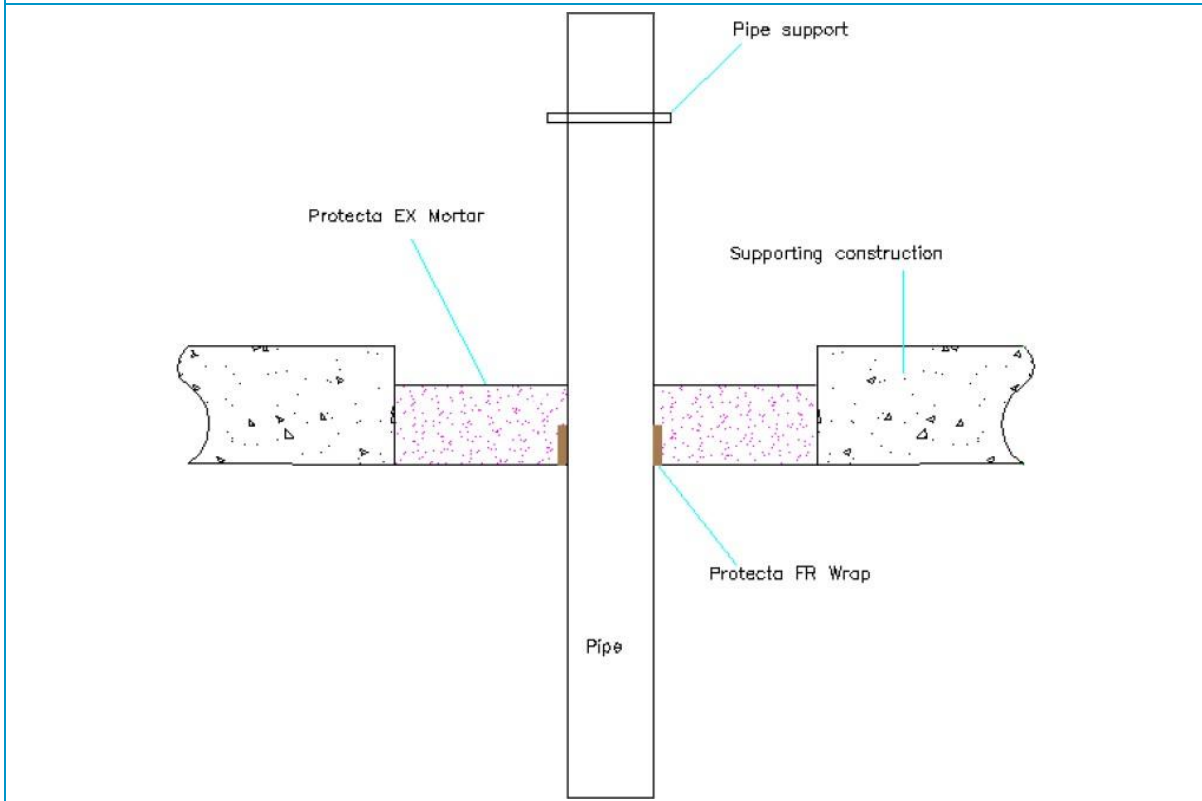


### 6.4.11 Pipe penetration seal with Protecta EX Mortar

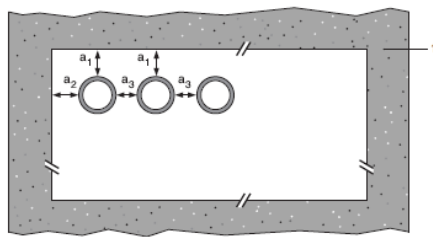
**Penetration seal:**

Plastic pipes fitted at any position within the aperture (min. separation 30 mm from seal edges and from other services), with Protecta EX Mortar to either surface of the floor or anywhere between. Protecta FR Pipe Wraps are required to be fitted to the bottom of the seal, as indicated below. Maximum seal size as section 4.1 4)

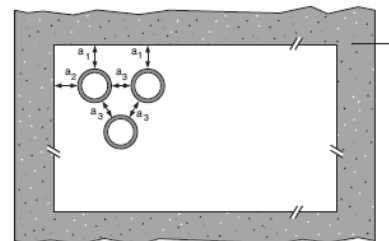
**Construction details:**



**Configuration 1**



**Configuration 2**



**Key**

- 1 Supporting construction
- a1 Pipe / top edge of seal separation
- a2 Pipe / side edge of seal separation
- a3 Pipe / pipe separation

**Table 32 Pipe penetration seal with Protecta EX Mortar**

Services	Wrap	Permitted configuration for seal separation	Min. mortar depth and floor thickness	FRL
<b>PVC-U pipes</b>				
Diameter 41 mm, wall thickness 1.8-3.7 mm to diameter 125 mm, wall thickness 4.8-7.4 mm*	50 mm × 7.2 mm (4 × 1.8 layers)	1 & 2	150 mm	-/60/60 U/U
125 mm diameter / 7.4 mm wall	50 mm × 7.2 mm (4 × 1.8 layers)	1 & 2	150 mm	-/120/120 U/U
Diameter 126 mm, wall thickness 4.8-7.4 mm to diameter 160 mm, wall thickness 9.5 mm*	75 mm × 10.8 mm (6 × 1.8 layers)	1	150 mm	-/120/30 U/U
160 mm diameter / 9.5 mm wall	75 mm × 7.2 mm (4 × 1.8 layers)	1	150 mm	-/120/30 U/U
160 mm diameter / 4.5-9.5 mm wall thickness	50 mm × 10.8 mm (6 × 1.8 layers)	1 & 2	120 mm	-/120/120 U/C, C/C
Diameter 161 mm, wall thickness 4.5-9.5 mm to diameter 200 mm, wall thickness 4.9-11.9 mm*	75 mm × 10.8 mm (6 × 1.8 layers)	1 & 2	120 mm	-/120/120 C/C
200 mm diameter / 4.9-11.9 mm wall thickness	75 mm × 10.8 mm (6 × 1.8 layers)	1 & 2	120 mm	-/240/240 C/C
Diameter 201 mm, wall thickness 4.9-11.9 mm to diameter 315 mm, wall thickness 7.7 mm*	75 mm × 18 mm (10 × 1.8 layers)	1	120 mm	-/120/120 C/C
315 mm diameter / 7.7 mm wall thickness	75 mm × 18 mm (10 × 1.8 layers)	1	120 mm	-/120/120 C/C
Diameter 161 mm, wall thickness 4.5-9.5 mm to diameter 315 mm, wall thickness 7.7-12.1 mm*	75 mm × 18 mm (10 × 1.8 layers)	1	120 mm	-/90/90 C/C
315 mm diameter / 12.1 mm wall thickness	75 mm × 18 mm (10 × 1.8 layers)	1	120 mm	-/90/90 C/C
Diameter 315 mm, wall thickness 7.7-12.1 mm to diameter 400 mm, wall thickness 15.3 mm*	75 mm × 28.8 mm (16 × 1.8 layers)	1	120 mm	-/60/60 C/C
400mm diameter / 15.3 mm wall thickness	75 mm × 28.8 mm (16 × 1.8 layers)	1 & 2	120 mm	-/60/60 C/C
*Typical pipe diameters shown, see below graph for intermediate sizes				

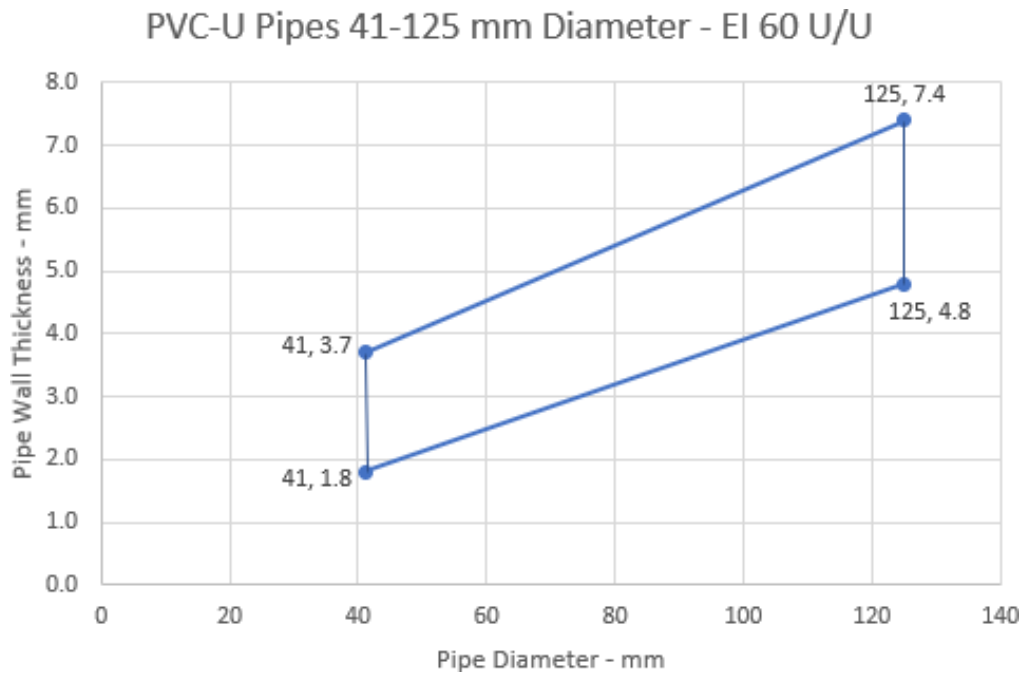


Figure 20 Intermediate pipe wall thicknesses for PVC-U pipe diameters from 41-125 mm

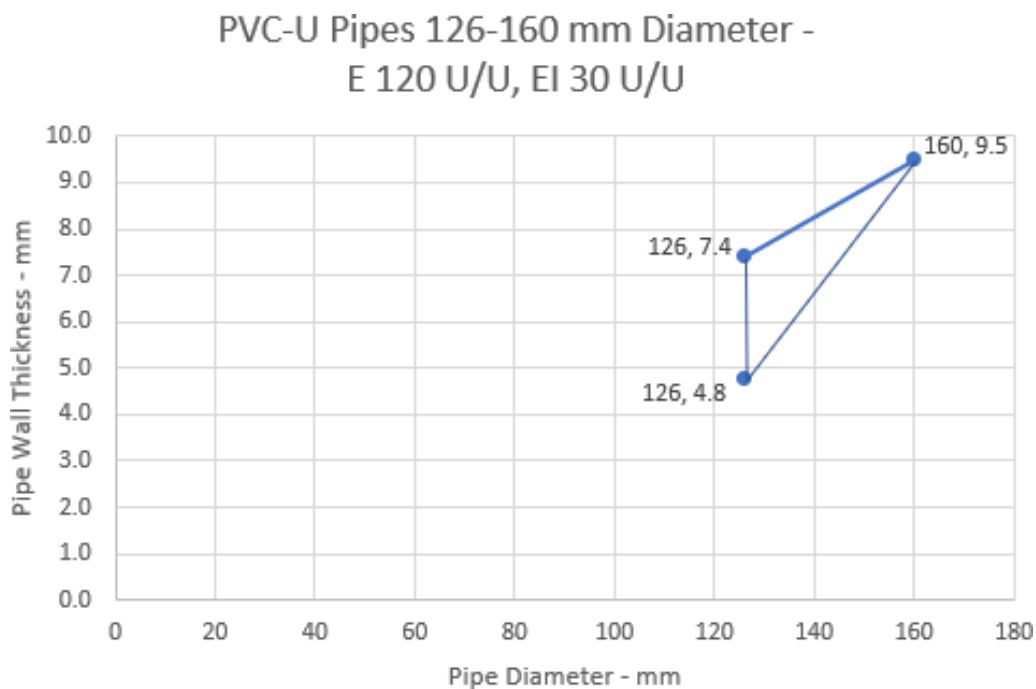


Figure 21 Intermediate pipe wall thicknesses for PVC-U pipe diameters from 126-160 mm

**PVC Pipes 161-200 mm Diameter - EI 120 - C/C**

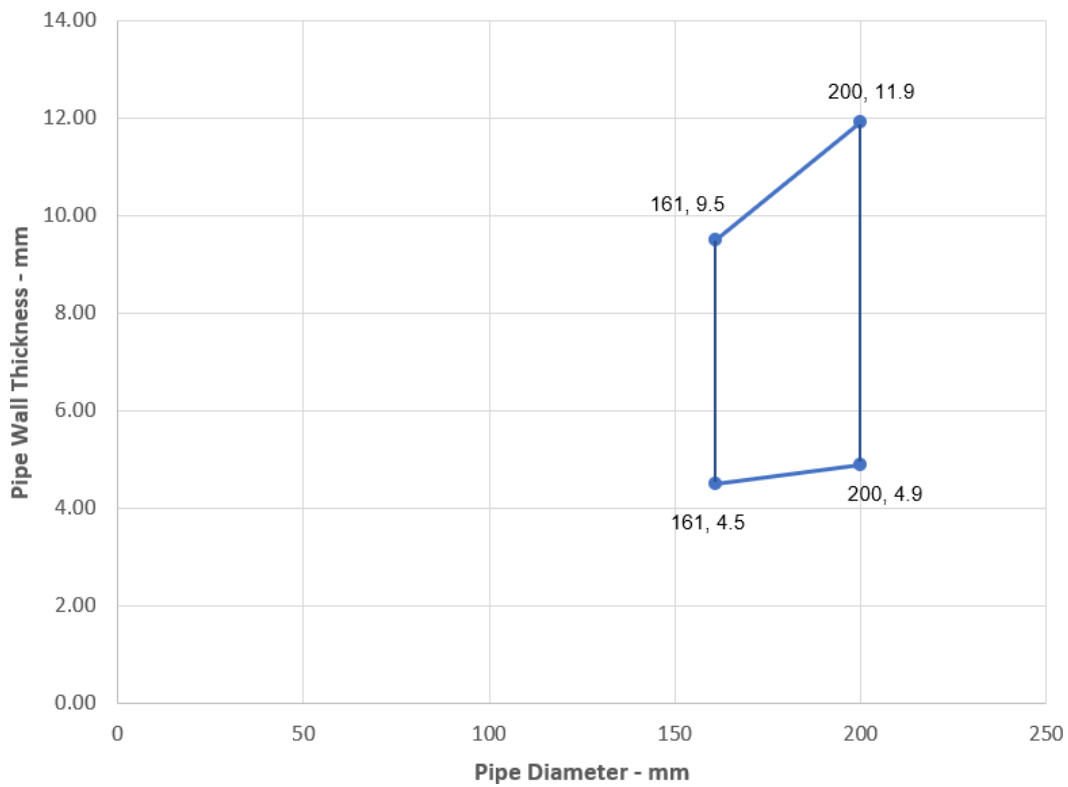
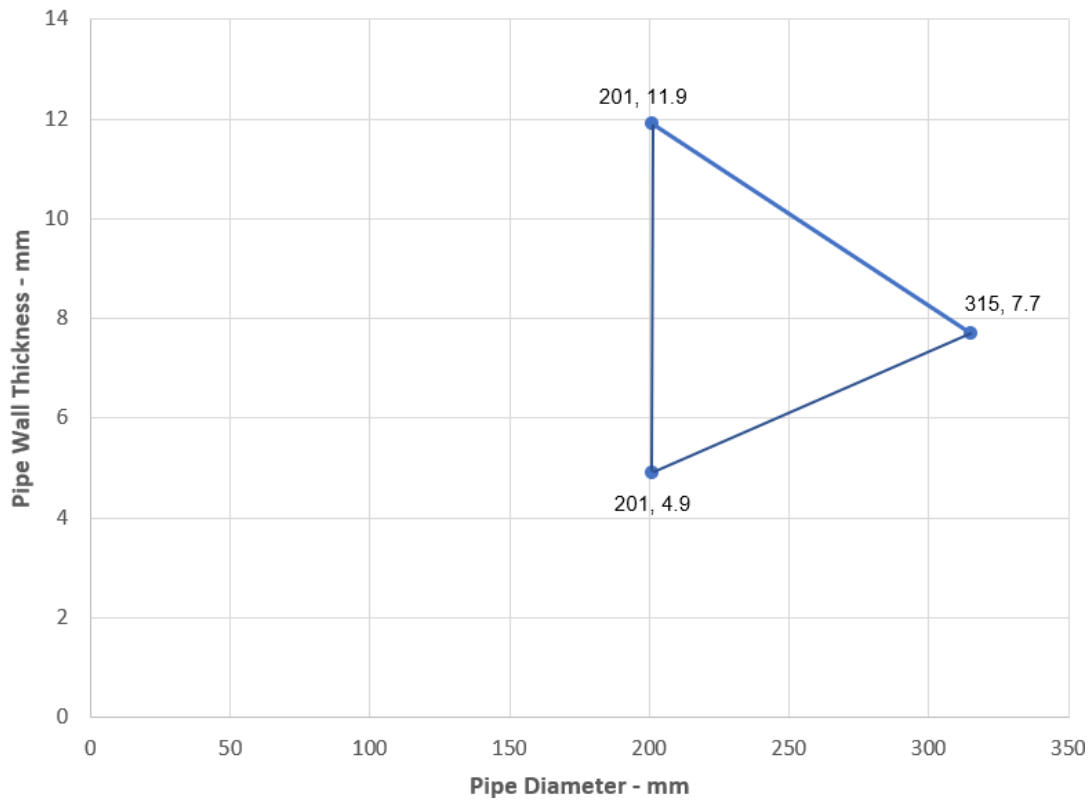
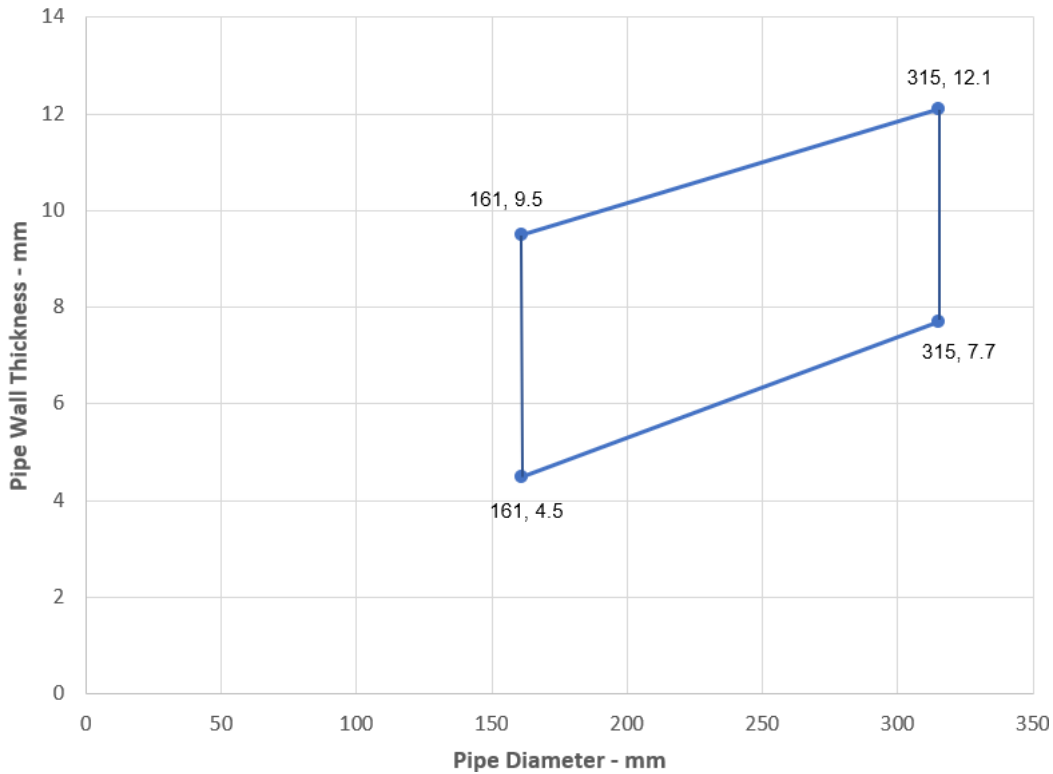


Figure 22 Intermediate pipe wall thicknesses for PVC-U pipe diameters from 161-200 mm

**PVC Pipes 201-315 mm Diameter - EI 120 - C/C**

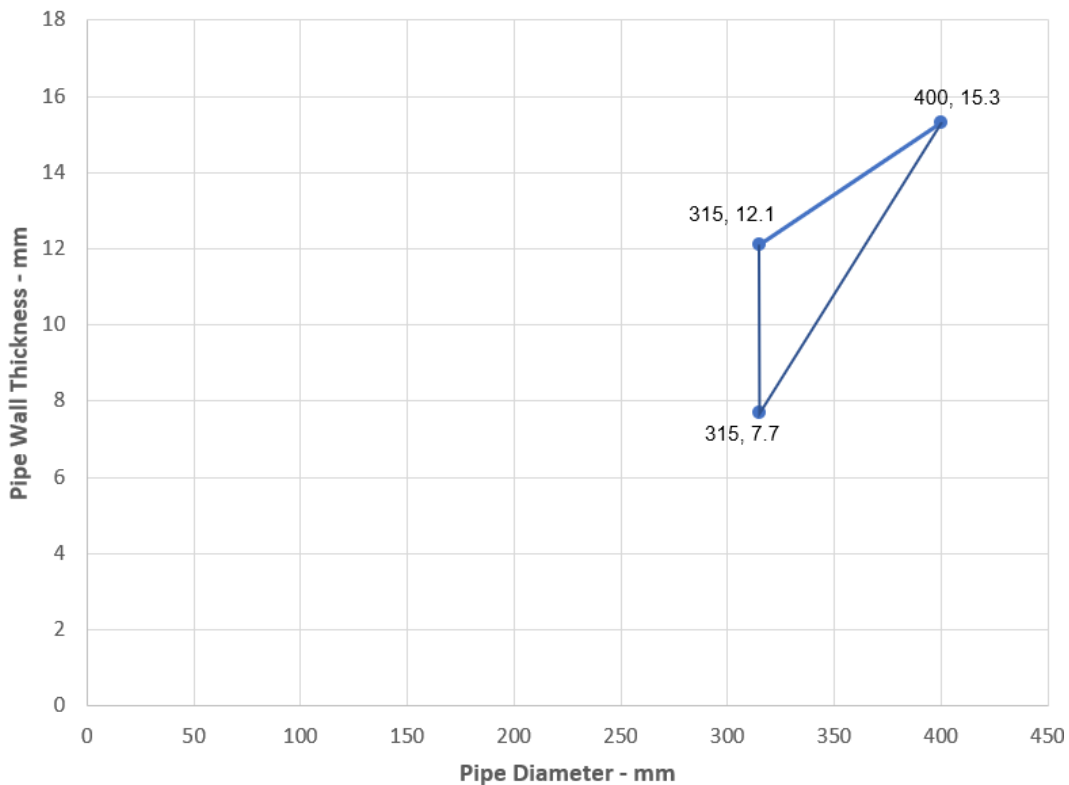


**Figure 23 Intermediate pipe wall thicknesses for PVC-U pipe diameters from 201-315 mm**  
**PVC Pipes 161-315 mm Diameter - EI 90 - C/C**



**Figure 24 Intermediate pipe wall thicknesses for PVC-U pipe diameters from 161-315 mm**

**PVC Pipes 315-400 mm Diameter - EI 60 - C/C**



**Figure 25 Intermediate pipe wall thicknesses for PVC-U pipe diameters from 315-400 mm**

**Table 33 Pipe penetration seal with Protecta EX Mortar**

Services	Wrap	Permitted configuration for seal separation	Min. mortar depth and floor thickness	FRL
<b>PP pipes</b>				
Diameter 41 mm, wall thickness 1.8-5.5 mm to diameter 160 mm, wall thickness 4.9-14.6 mm*	75 mm × 10.8 mm (6 × 1.8 layers)	1 & 2	150 mm	-/120/120 U/C
160 mm diameter / 14.6 mm wall	75 mm × 7.2 mm (4 × 1.8 layers)	1 & 2	150 mm	-/240/240 U/U
Diameter 161 mm, wall thickness 4.9-14.6 mm to diameter 200 mm, wall thickness 4.9-18.2 mm*	75 mm × 10.8 mm (6 × 1.8 layers)	1 & 2	120 mm	-/240/240 C/C
Diameter 201 mm, wall thickness 4.9-18.2 mm to diameter 315 mm, wall thickness 7.7 mm*	75 mm × 18 mm (10 × 1.8 layers)	N/A	150 mm	-/180/180 C/C
Diameter 201 mm, wall thickness 4.9-18.2 mm to diameter 315 mm, wall thickness 7.7-28.6 mm*	75 mm × 18 mm (10 × 1.8 layers)	N/A	150 mm	-/60/60 C/C
315 mm diameter / 7.7 mm wall	75 mm × 18 mm (10 × 1.8 layers)	N/A	150 mm	-/180/180 C/C
315 mm diameter / 7.7-28.6 mm wall	75 mm × 18 mm (10 × 1.8 layers)	1	150 mm	-/60/60 C/C
Diameter 315 mm, wall thickness 7.7-28.6 mm to diameter 400 mm, wall thickness 22.7 mm*	75 mm × 28.8 mm (16 × 1.8 layers)	1	150 mm	-/60/60 C/C
400mm diameter / 22.7 mm wall thickness	75 mm × 28.8 mm (16 × 1.8 layers)	1 & 2	150 mm	-/60/60 C/C
*Typical pipe diameters shown, see below graph for intermediate sizes				

PP Pipes 41-160 mm Diameter - EI 120 U/C

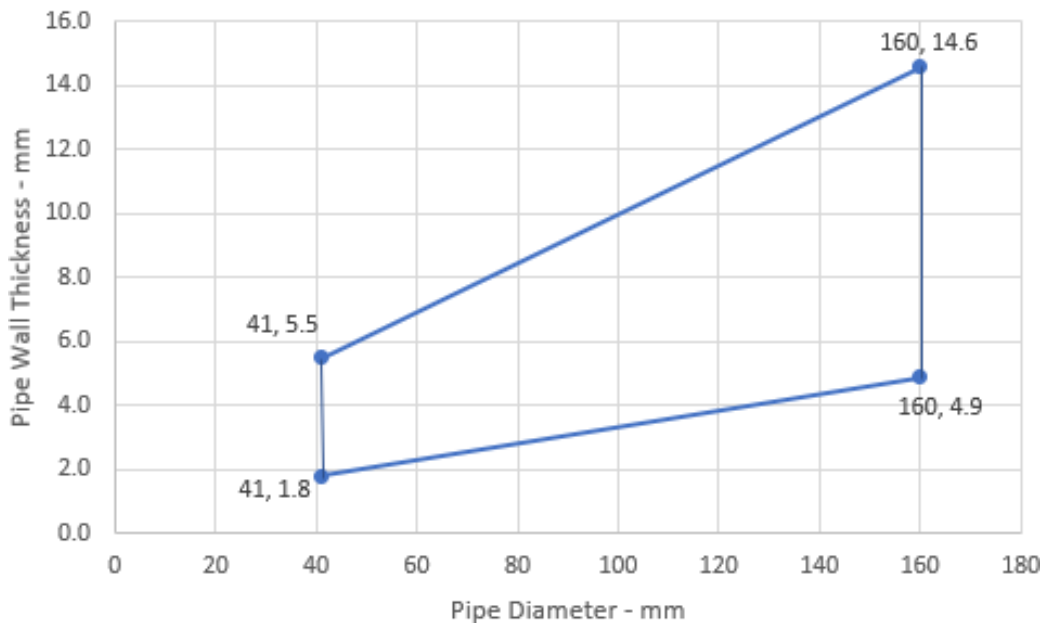


Figure 26 Intermediate pipe wall thicknesses for PP pipe diameters from 41-160 mm

PP Pipes - EI 240 C/C

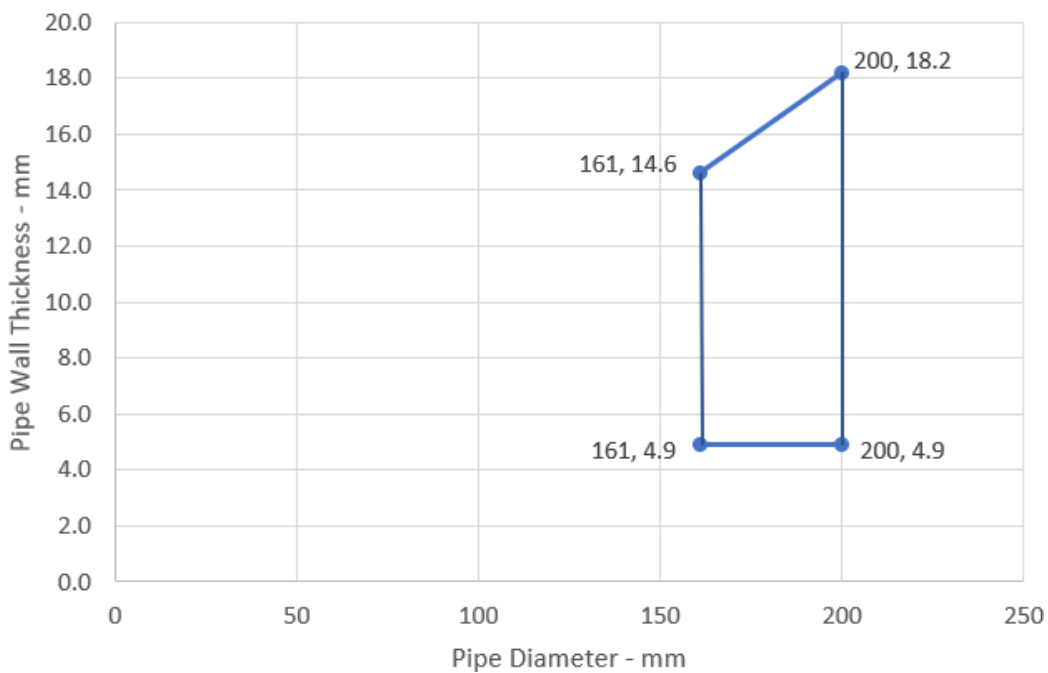


Figure 27 Intermediate pipe wall thicknesses for PP pipe diameters from 161-200 mm

**PP Pipes 201-315 mm Diameter - EI 180 - C/C**

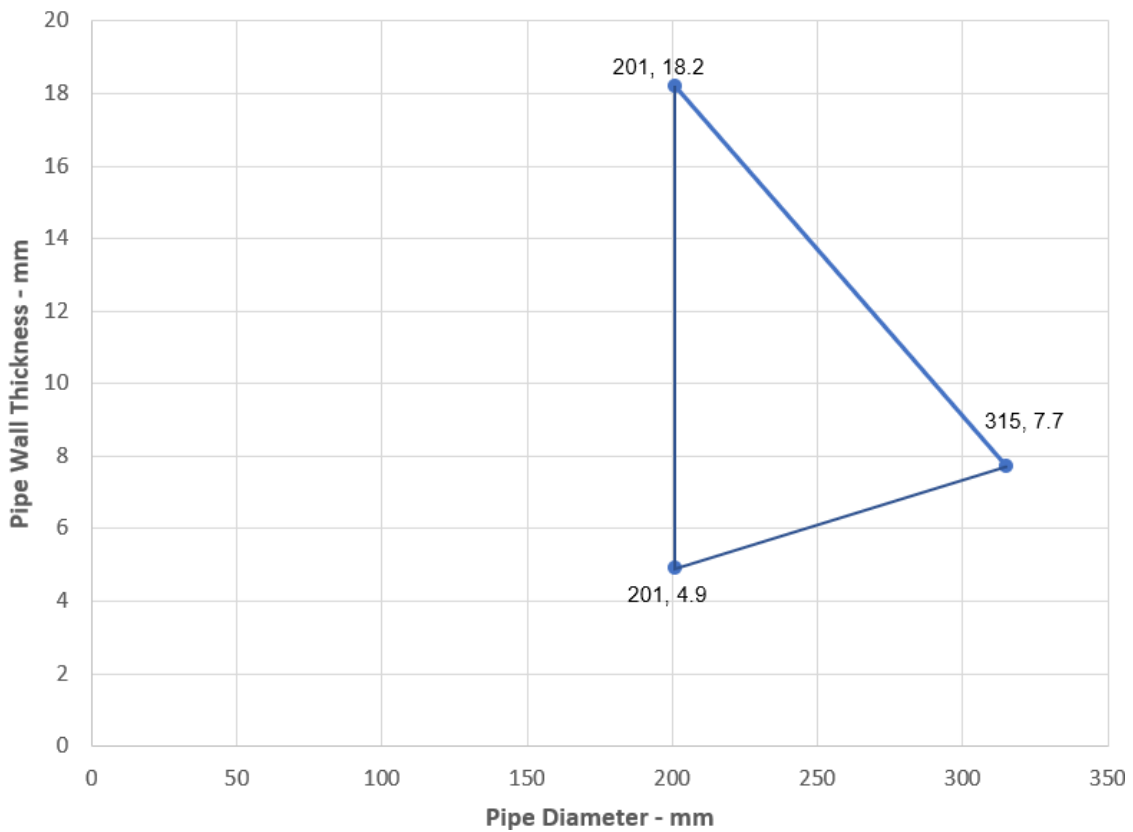
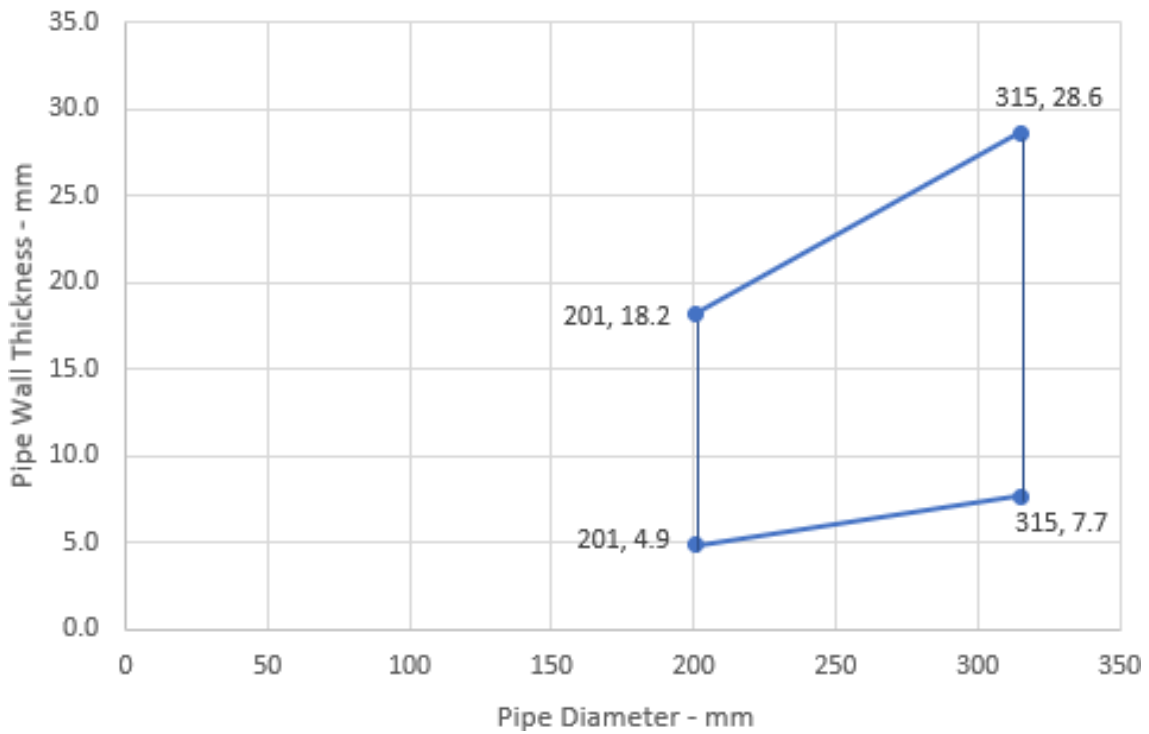


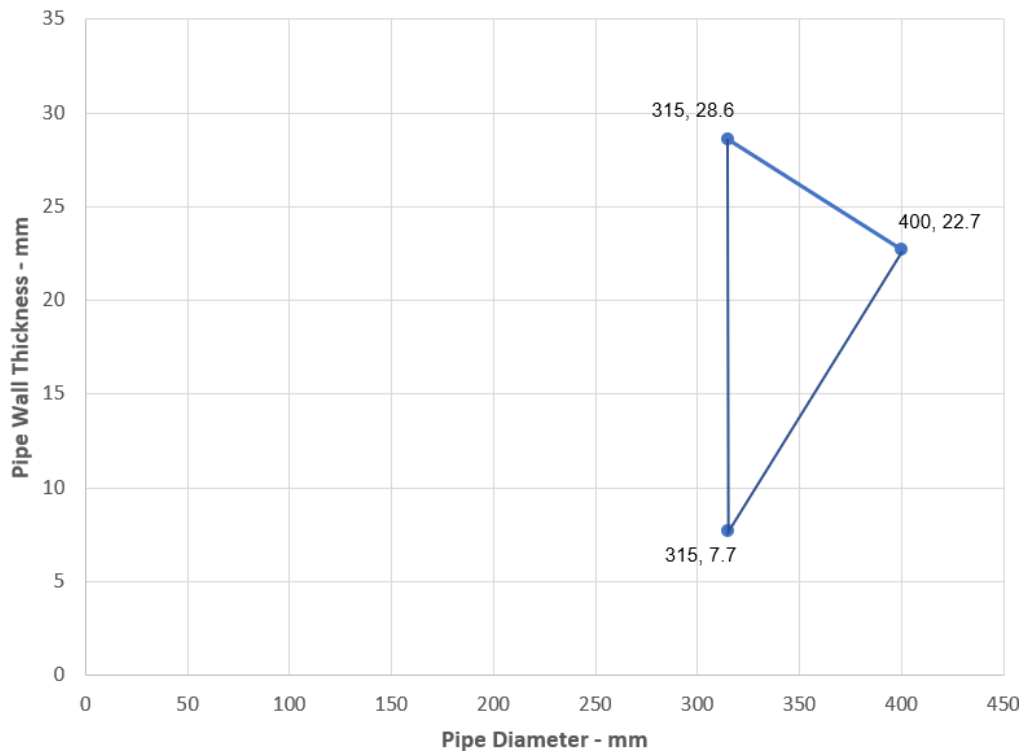
Figure 28 Intermediate pipe wall thicknesses for PP pipe diameters from 201-315 mm

**PP Pipes - EI 60 C/C**





**Figure 29 Intermediate pipe wall thicknesses for PP pipe diameters from 201-315 mm**  
**PP Pipes 315-400 mm Diameter - EI 60 - C/C**



**Figure 30 Intermediate pipe wall thicknesses for PP pipe diameters from 315-400 mm**

**Table 34 Pipe penetration seal with Protecta EX Mortar**

Services	Wrap	Permitted configuration for seal separation	Min. mortar depth and floor thickness	FRL
<b>PE pipes</b>				
Diameter 126 mm, wall thickness 3.9-11.4 mm to diameter 160 mm, wall thickness 14.6*	75 mm × 18 mm (10 × 1.8 layers)	N/A	150 mm	-/240/120 U/U
160 mm diameter / 14.6 mm wall	75 mm × 7.2 mm (4 × 1.8 layers)	1 & 2	150 mm	-/240/120 U/U
Diameter 161 mm, wall thickness 4.9-14.6 mm to diameter 200 mm, wall thickness 6.2-18.2 mm*	75 mm × 10.8 mm (6 × 1.8 layers)	1 & 2	150 mm	-/120/120 C/C
200 mm diameter / 6.2-18.2 mm wall thickness	75 mm × 10.8 mm (6 × 1.8 layers)	1 & 2	120 mm	-/240/240 C/C
Diameter 161 mm, wall thickness 4.9-14.6 mm to diameter 315 mm, wall thickness 9.7-18.7 mm*	75 mm × 18 mm (10 × 1.8 layers)	N/A	150 mm	-/60/60 C/C
*Typical pipe diameters shown, see below graph for intermediate sizes				

PE Pipes 126-160 mm Diameter -  
E 240 U/U, EI 120 U/U

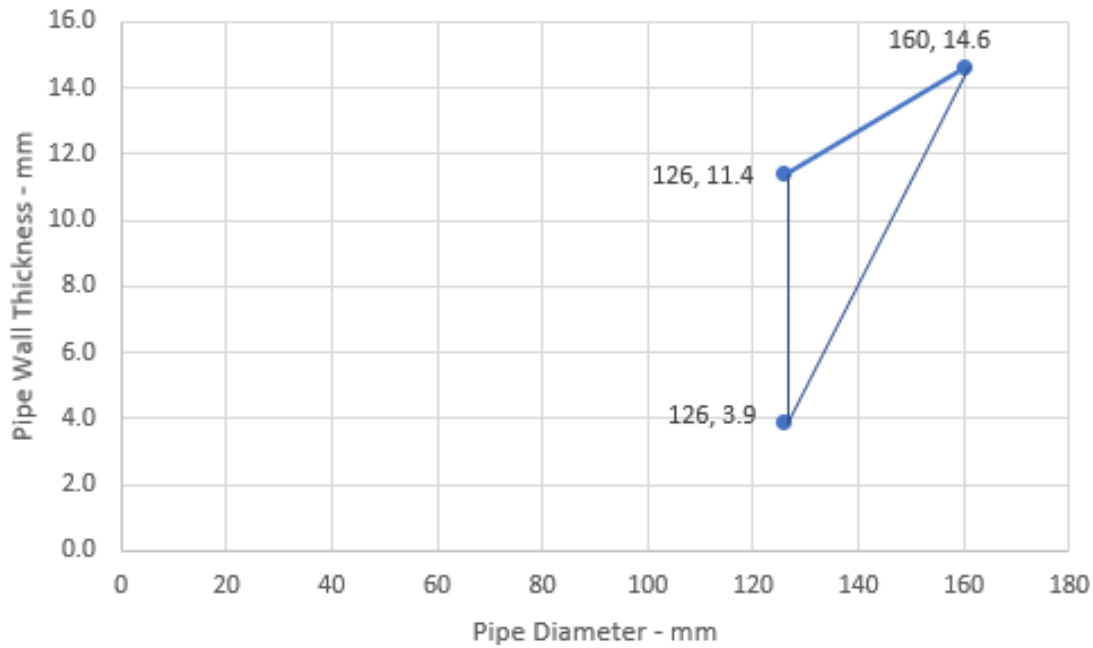


Figure 31 Intermediate pipe wall thicknesses for PE pipe diameters from 126-160 mm

PE Pipes 161-200 mm Diameter - EI 120 - C/C

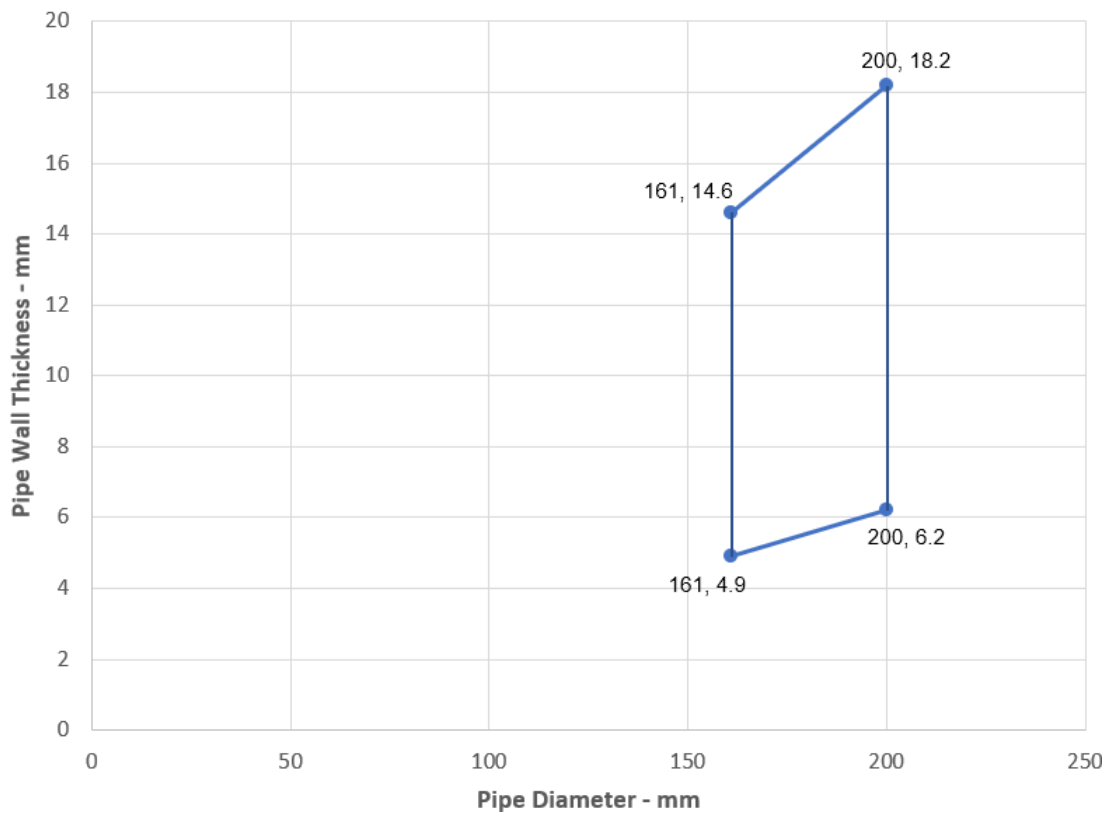


Figure 32 Intermediate pipe wall thicknesses for PE pipe diameters from 161-200 mm

### PE Pipes - EI 60 C/C

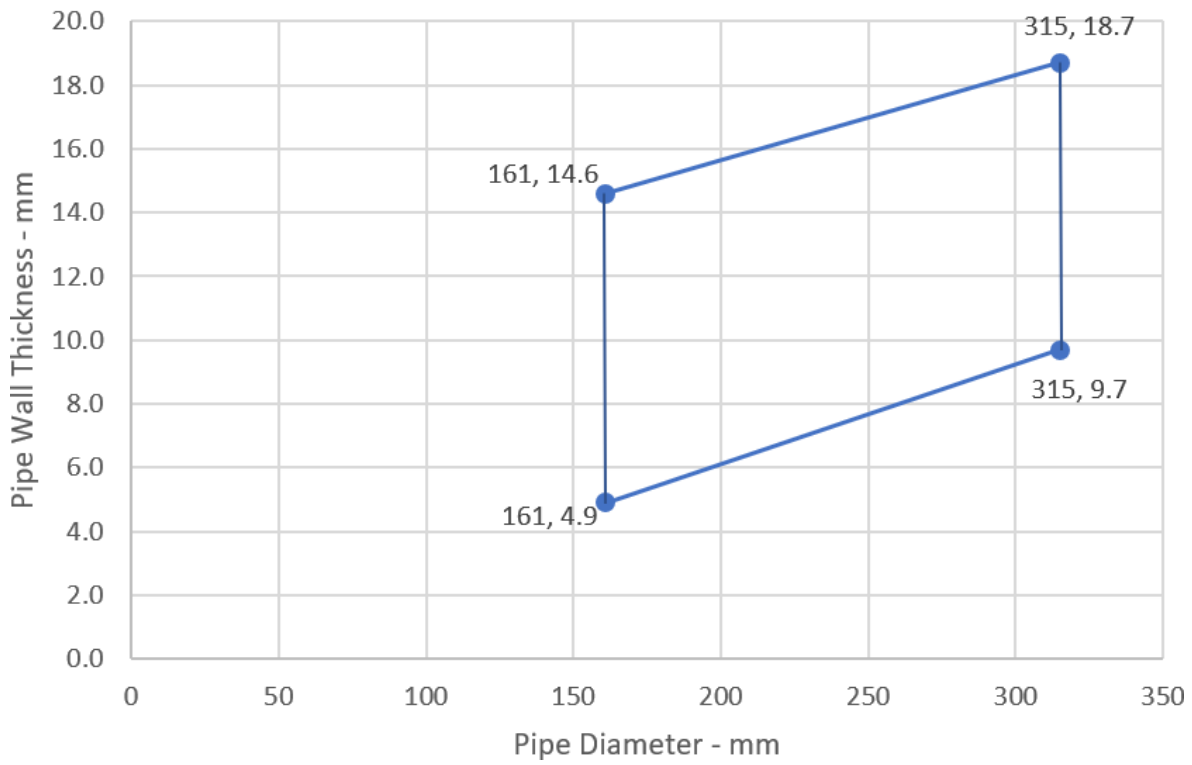


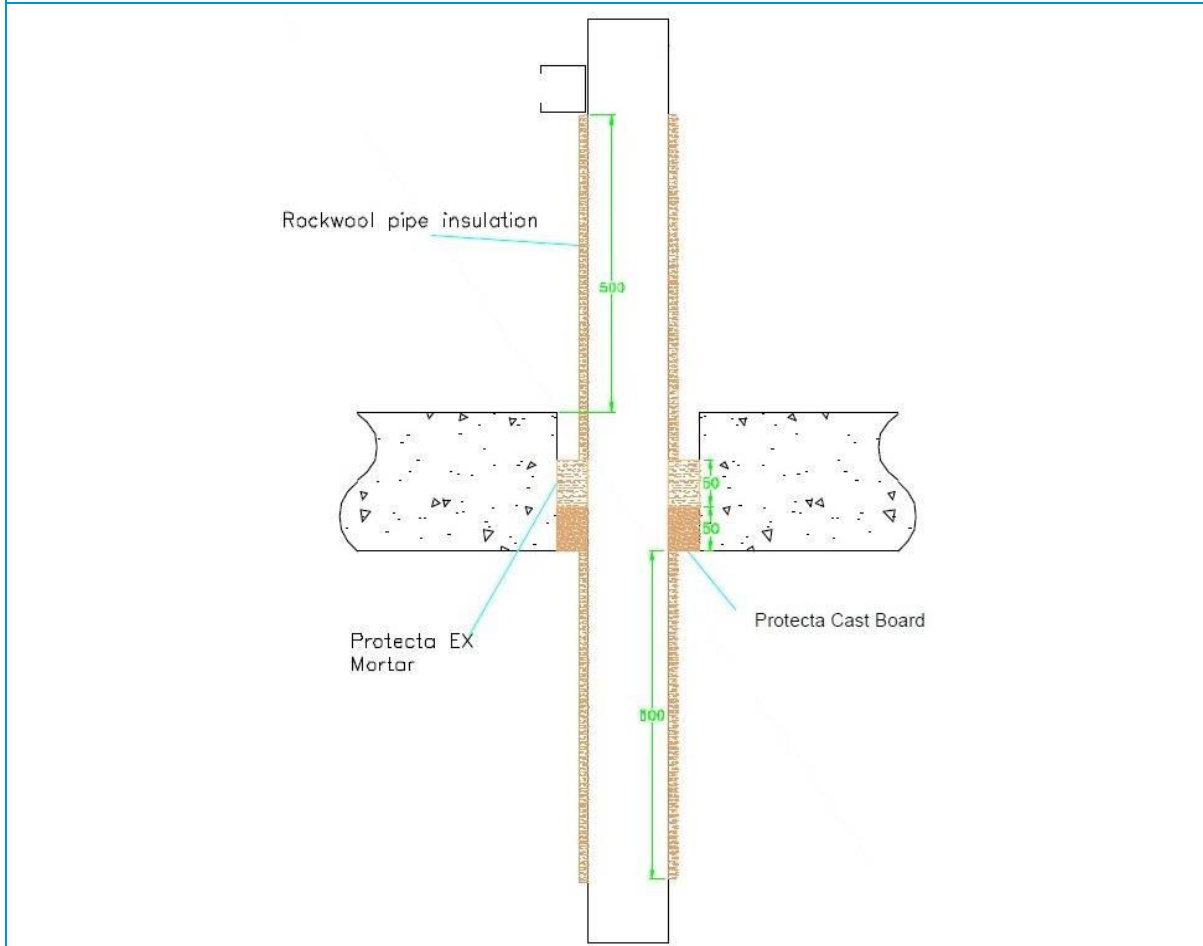
Figure 33 Intermediate pipe wall thicknesses for PE pipe diameters from 161-315 mm

### 6.4.12 Pipe penetration seal with 50 mm deep Protecta EX Mortar

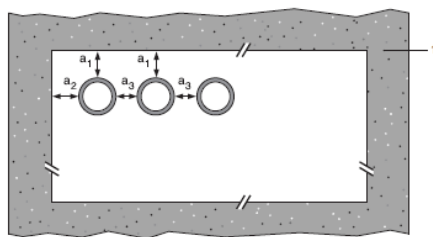
**Penetration seal:**

CI (Continuous Interrupted) or LI (Local Interrupted) insulated composite pipes fitted at any position within the aperture (min. separation 10 mm from seal edges), with min. 50 mm Protecta EX Mortar to either surface of the floor or anywhere between, backed with min. 50 mm stone wool min. 150 kg/m<sup>3</sup>.

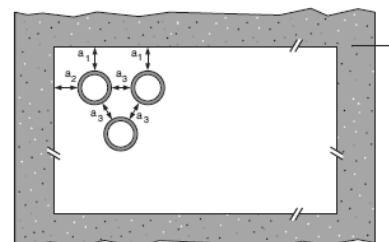
**Construction details:**



**Configuration 1**



**Configuration 2**



**Key**

- 1 Supporting construction
- a1 Pipe / top edge of seal separation
- a2 Pipe / side edge of seal separation
- a3 Pipe / pipe separation

**Table 35 Single side penetration seal with pipes**

Services	Maximum Aperture	Insulation	FRL	
<b>Alupex pipes</b>				
16 mm diameter/2.25 mm wall*	135 mm × 135 mm	500 mm long, minimum 20 mm Stone wool insulation minimum 80 kg/m <sup>3</sup>	-/240/240 C/C	
16 mm diameter/2.25 mm wall*			-/240/180 C/C	
20 mm diameter/2.5 mm wall*				
26 mm diameter/3 mm wall*				
32 mm diameter/3 mm wall*				
40 mm diameter/3.5 mm wall*				
50 mm diameter/4 mm wall*				
63 mm diameter/4.5 mm wall*				
75 mm diameter/4.7 mm wall*				
16 mm diameter/2.25 mm wall*	As section 4.1 4)		-/180/180 C/C	
20 mm diameter/2.5 mm wall*				
26 mm diameter/3 mm wall*				
32 mm diameter/3 mm wall*				
40 mm diameter/3.5 mm wall*				
50 mm diameter/4 mm wall*				
63 mm diameter/4.5 mm wall*				
75 mm diameter/4.7 mm wall*				
*Typical pipe diameters shown, see below graph for intermediate sizes				

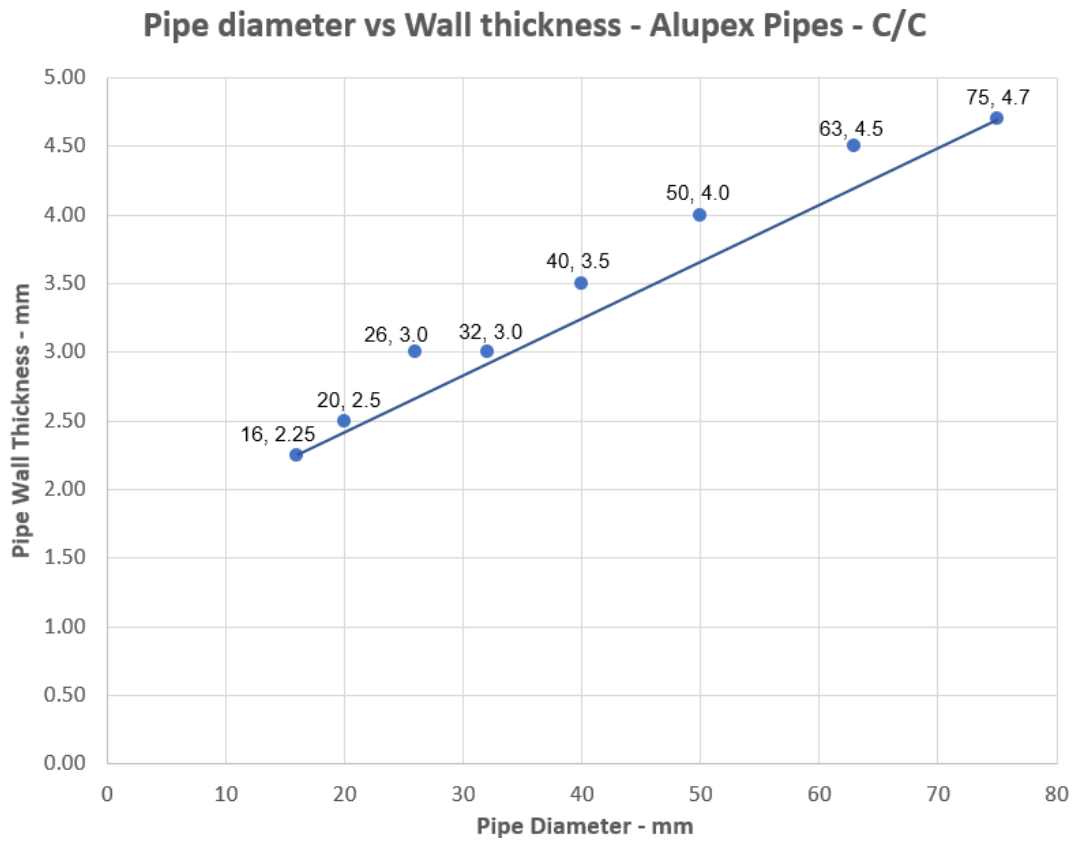


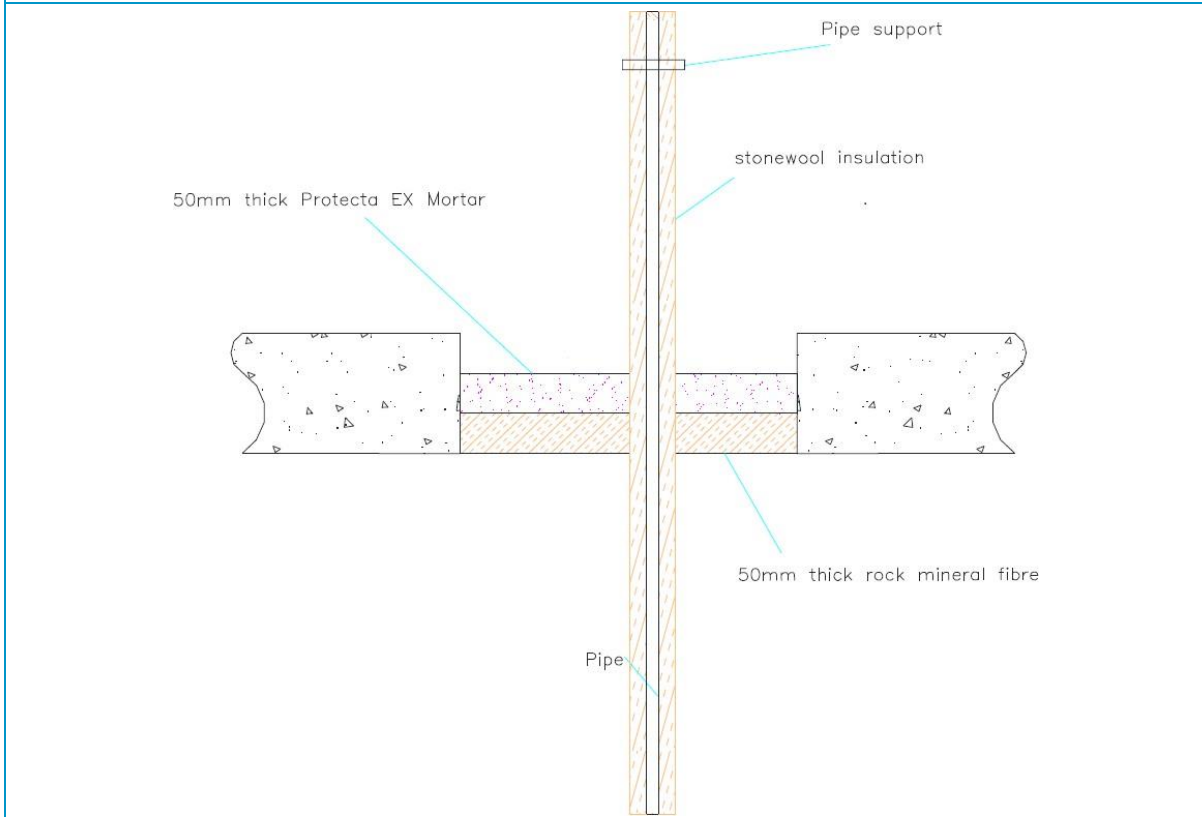
Figure 34 Intermediate pipe wall thicknesses for Alupex pipe diameters

### 6.4.13 Pipe penetration seal with 50 mm deep Protecta EX Mortar

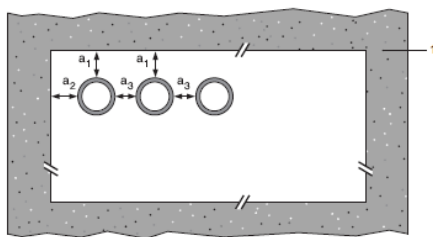
**Penetration seal:**

CS (Continuous Sustained) insulated metal pipes, uninsulated metal pipes and composite with Protecta EX Mortar, to either side of the floor, backed with stone wool board min. 150 kg/m<sup>3</sup>. Minimum separation from pipes to seal edges of 30 mm (a1 & a2). Maximum seal size as section 4.1 4)

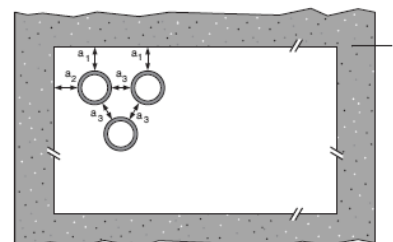
**Construction details:**



**Configuration 1**



**Configuration 2**



**Key**

- 1 Supporting construction
- a1 Pipe / top edge of seal separation
- a2 Pipe / side edge of seal separation
- a3 Pipe / pipe separation

**Table 36 Single side penetration seal with pipes**

Services	Maximum Aperture	Insulation	FRL	
<b>Copper or steel pipes</b>				
12 -54 mm diameter/0.7-14.2 mm wall*	As section 4.1 4)	20-80 mm Stone wool insulation minimum 80 kg/m <sup>3</sup>	-/180/120 C/C	
6 mm diameter/0.7-3 mm wall*		None	-/180/120 C/C	
7-15 mm diameter/0.7-7.5 mm wall*			-/180/30 C/C	
16-54mm diameter/1.2-14.2mm wall*			-/180/- C/C	
<b>Steel pipes</b>				
4-16 mm diameter/1.0-8.0 mm wall*		None	-/180/180 C/U	
17-324 mm diameter/6.35-14.2 mm wall*			-/180/- C/U	
<b>Alupex pipes</b>				
16-20 mm diameter/2.0 mm wall		None	-/180/180 C/C	
75mm diameter/4.6mm wall			-/180/30 C/C	
16 mm diameter/2.25 mm wall	20 mm glass- or stone wool insulation minimum 75 kg/m <sup>3</sup>	-/180/180 C/C		
16-75 mm diameter/2.25-4.6 wall*	25-50 mm glass- or stone wool insulation minimum 75 kg/m <sup>3</sup>	-/120/120 C/C		
*Typical pipe diameters shown, see below graph for intermediate sizes				



### Copper and Steel pipes with Stonewool Insulation CS

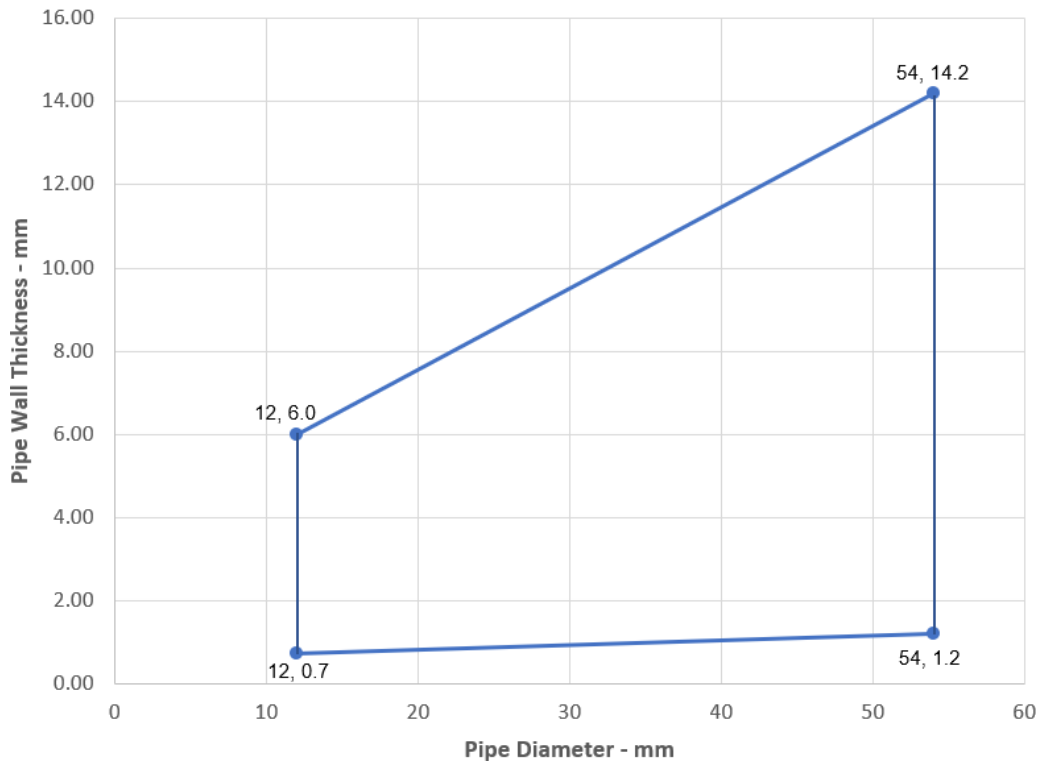


Figure 35 Intermediate pipe wall thicknesses for Copper or steel pipe diameters (with CS insulation)

### Copper and Steel pipes without Insulation

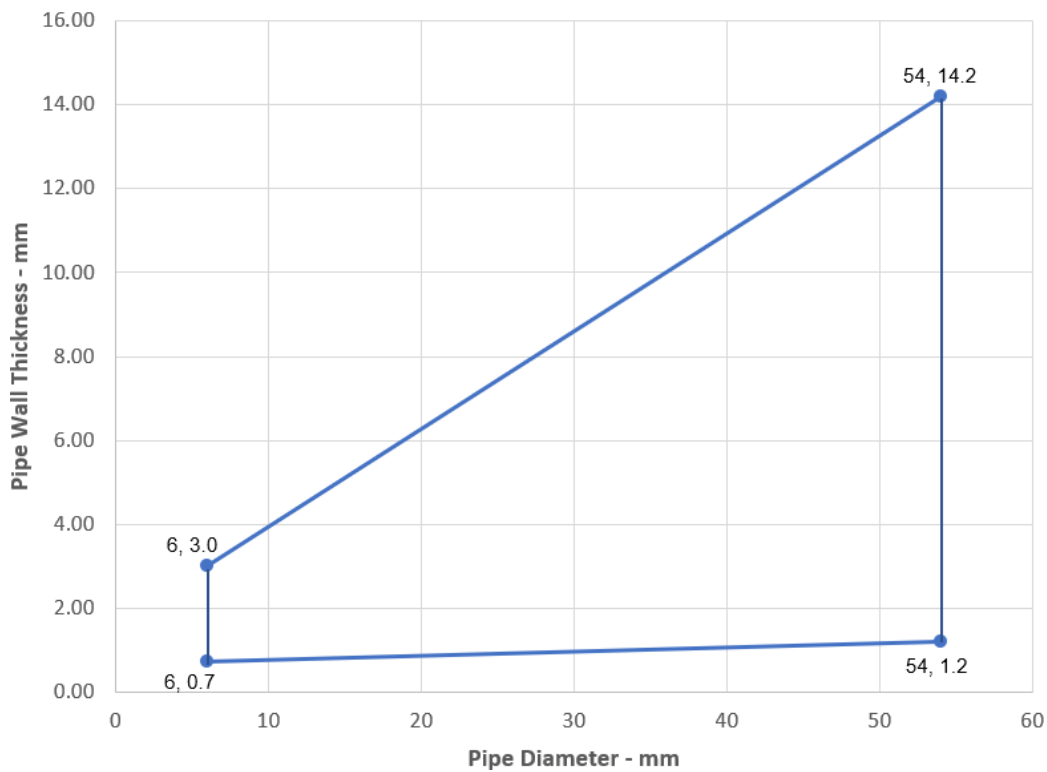
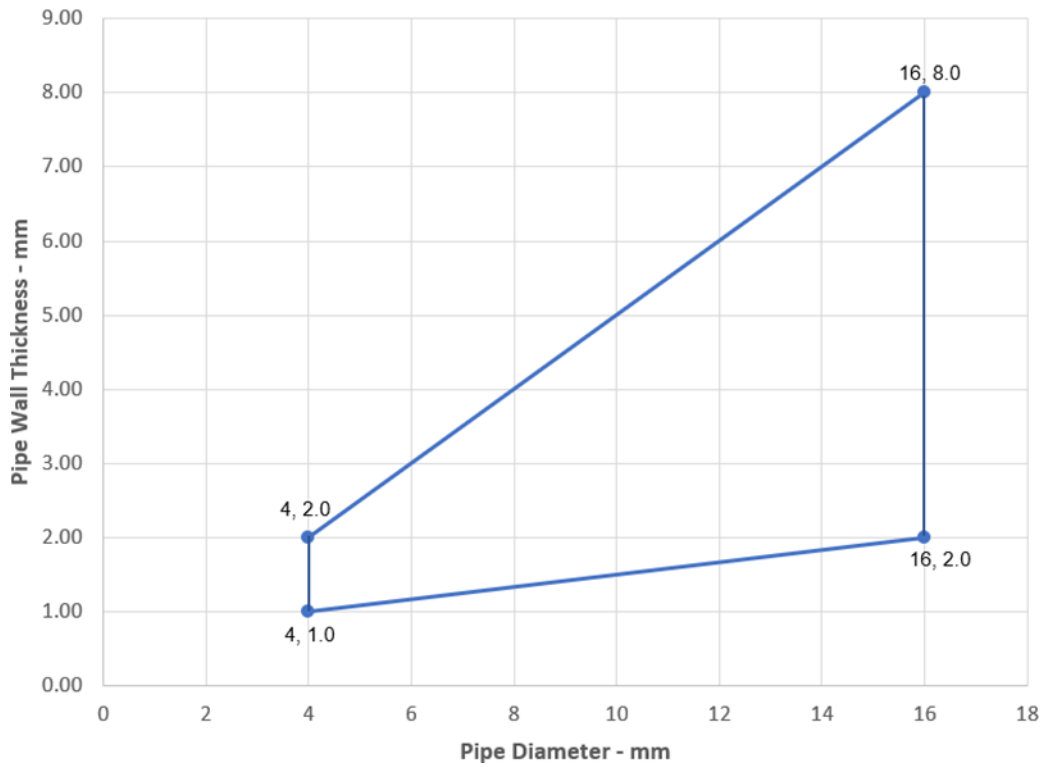


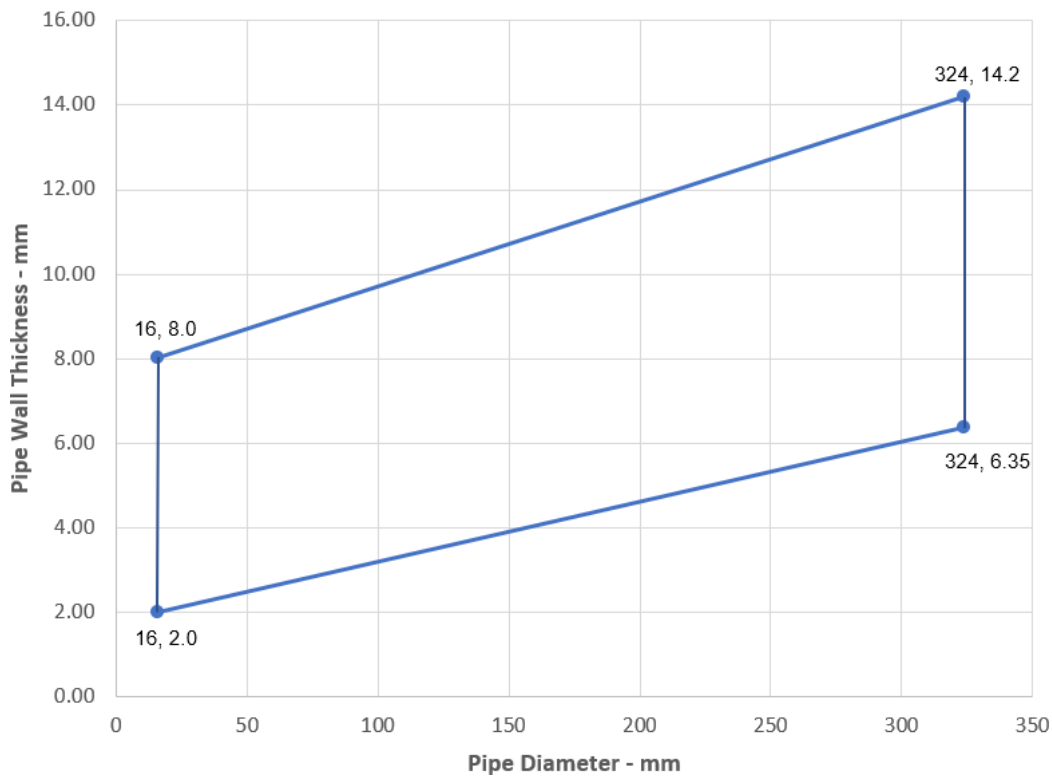
Figure 36 Intermediate pipe wall thicknesses for Copper or steel pipe diameters without insulation

**Steel pipes 4-16 mm Diameter without Insulation**



**Figure 37** Intermediate pipe wall thicknesses for steel pipe diameters 4-16 mm without insulation

**Steel pipes 16-324 mm Diameter without Insulation**



**Figure 38** Intermediate pipe wall thicknesses for steel pipe diameters 16-324 mm without insulation

### Alupex pipes 16-75 mm Diameter with Glass or Stonewool Insulation CS

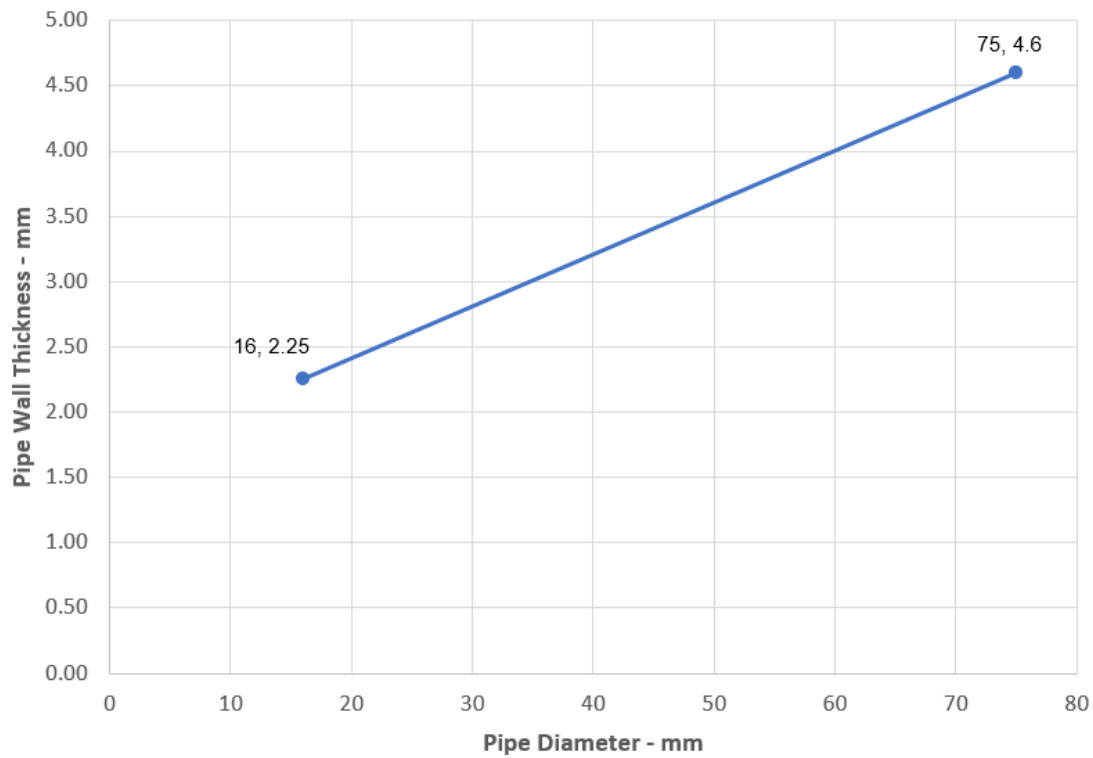


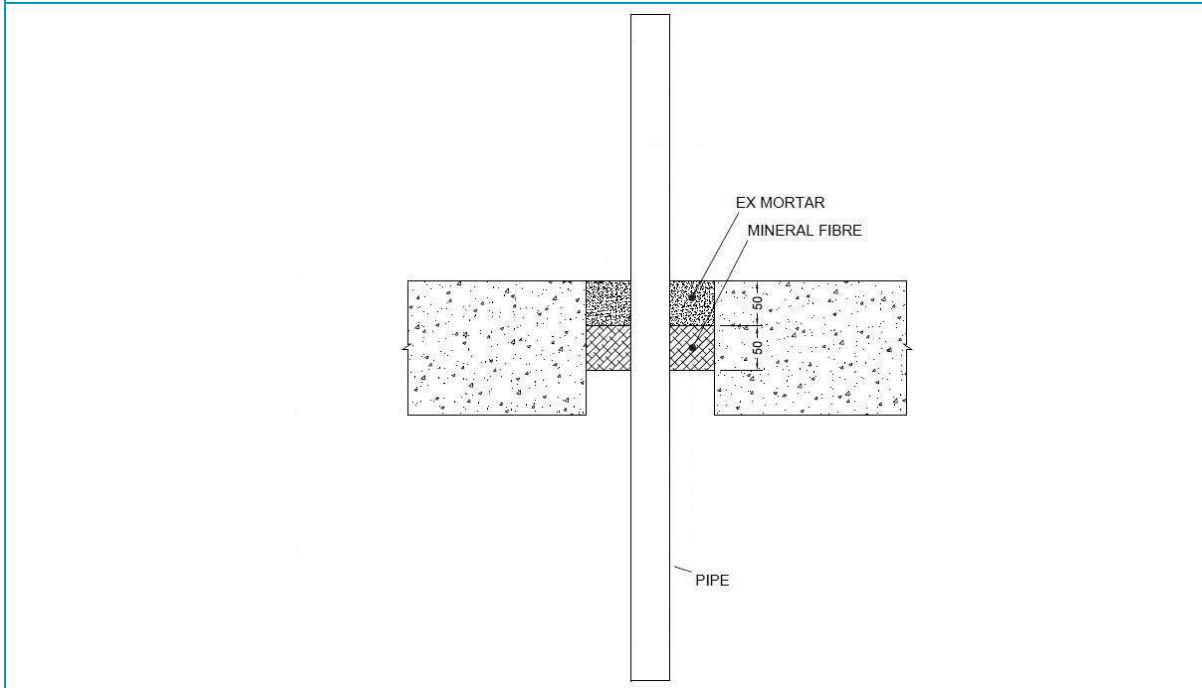
Figure 39 Intermediate pipe wall thicknesses for Alupex pipe diameters 16-75 mm with CS insulation

### 6.4.14 Pipe penetration seal with 50 mm deep Protecta EX Mortar

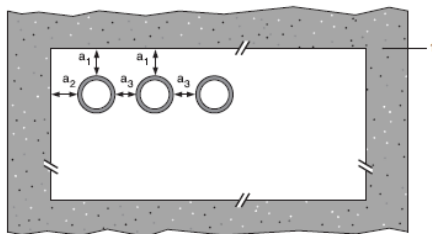
**Penetration seal:**

Plastic pipes fitted at any position within the aperture (min. separation 30 mm from seal edges and 30 mm from other services), with min. 50 mm Protecta EX Mortar flush with the top of floor, backed with min. 50 mm stone wool min. 150 kg/m<sup>3</sup>.

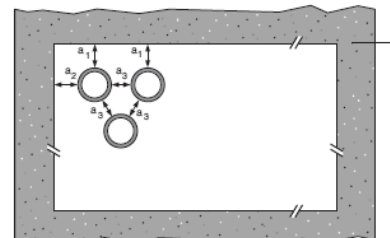
**Construction details:**



**Configuration 1**



**Configuration 2**



**Key**

- 1 Supporting construction
- a1 Pipe / top edge of seal separation
- a2 Pipe / side edge of seal separation
- a3 Pipe / pipe separation

**Table 37 Single sided penetration seal with pipes**

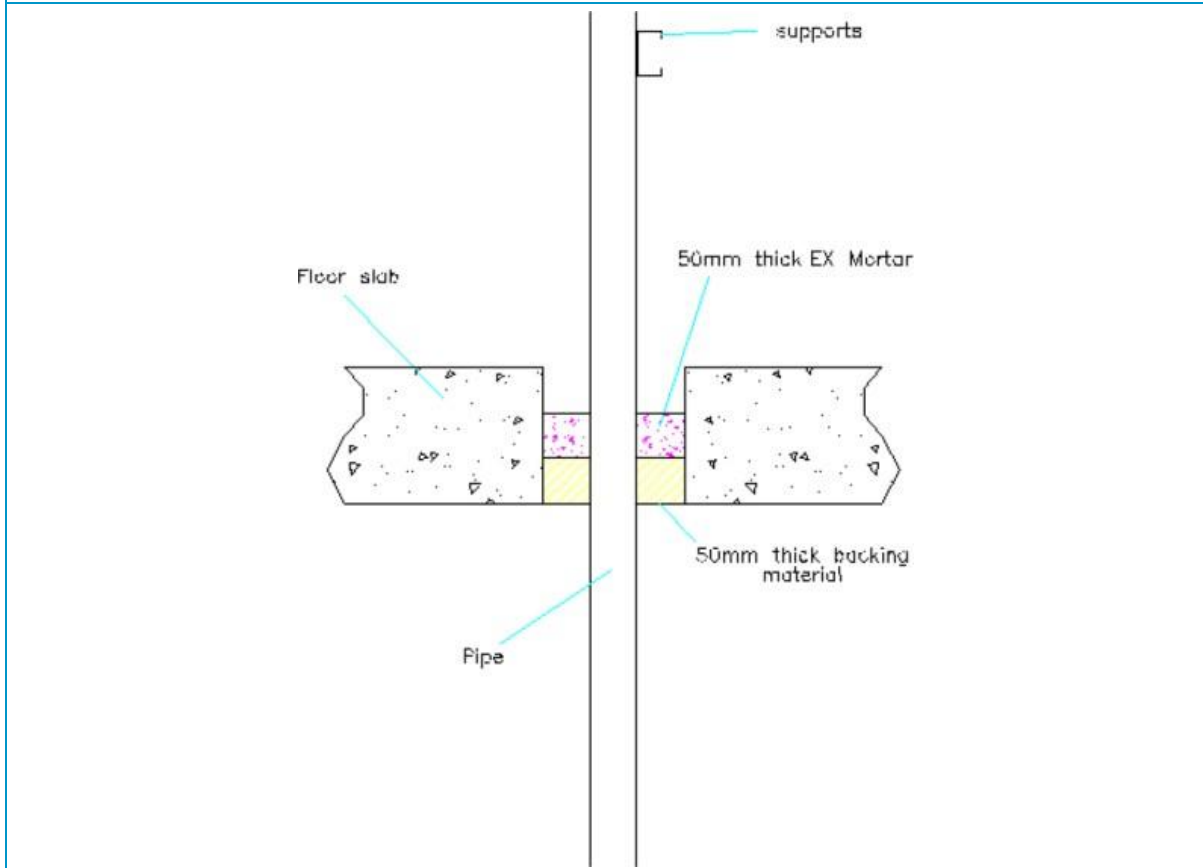
Services	Wrap	Maximum aperture	FRL
40 mm diameter /3 mm wall PP pipes	None	As section 4.1 4)	-/120/120 C/C
40 mm diameter /4 mm wall PE pipes			
110 mm diameter /4.3 mm wall PE pipes	50 mm × 1.8 mm		-/60/60 C/C

### 6.4.15 Pipe penetration seal with 50 mm deep Protecta EX Mortar

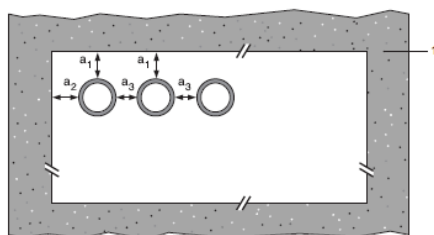
**Penetration seal:**

Combustible pipes sealed with Protecta EX Mortar, to either side of the floor, backed with stone wool board min. 150 kg/m<sup>3</sup>. Minimum separation between pipes of 30 mm (a3) and from seal edges 30 mm (a1 & a2). Maximum seal size as section 4.1 4)

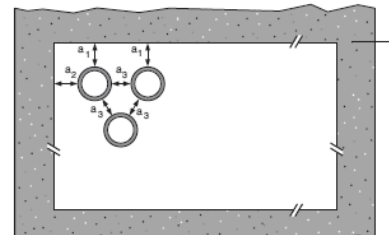
**Construction details:**



**Configuration 1**



**Configuration 2**



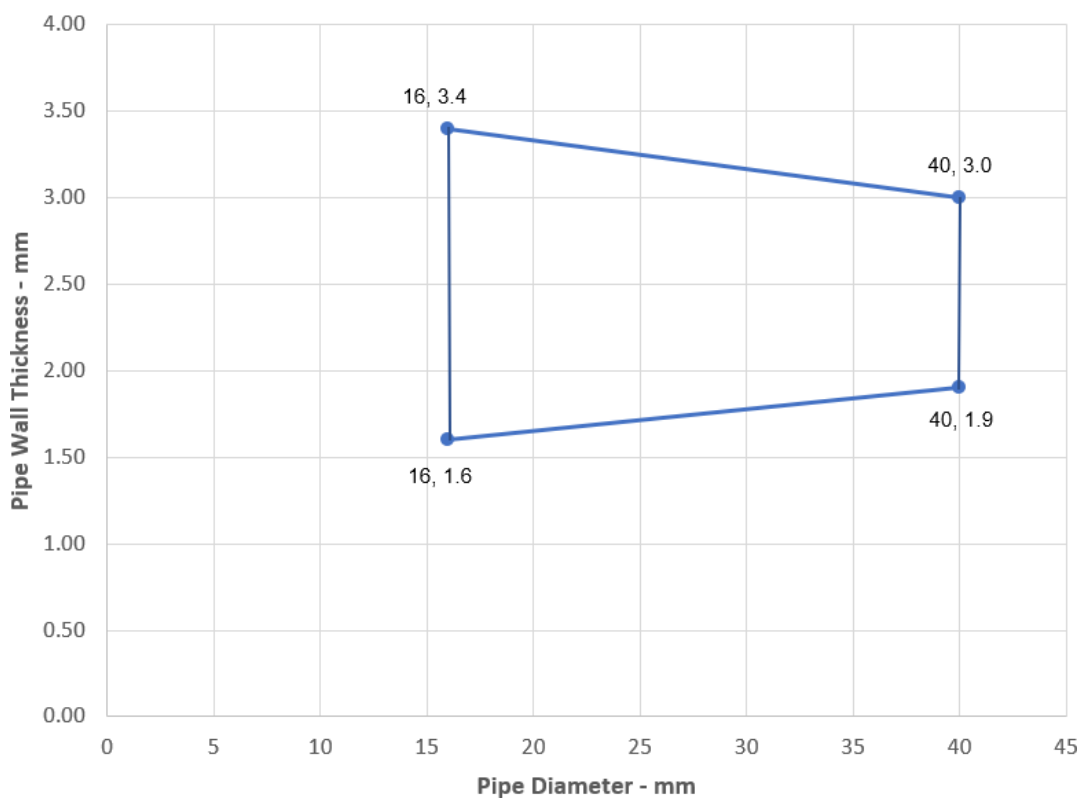
**Key**

- 1 Supporting construction
- a1 Pipe / top edge of seal separation
- a2 Pipe / side edge of seal separation
- a3 Pipe / pipe separation

**Table 38 Single side penetration seal with cables**

Services	Seal Depth	Permitted configuration for seal separation	FRL
<b>PVC-U pipes</b>			
Diameter 16 mm, wall thickness 1.6 – 3.4 mm, to diameter 40 mm, wall thickness 1.9-3.0 mm*	Min. 50 mm	1 & 2 between all specified pipes	-/120/120 U/C, C/C
*See below graph for intermediate sizes			

**PVC Pipes - EI 120 - U/C**



**Figure 40 Intermediate pipe wall thicknesses for PVC pipe diameters**

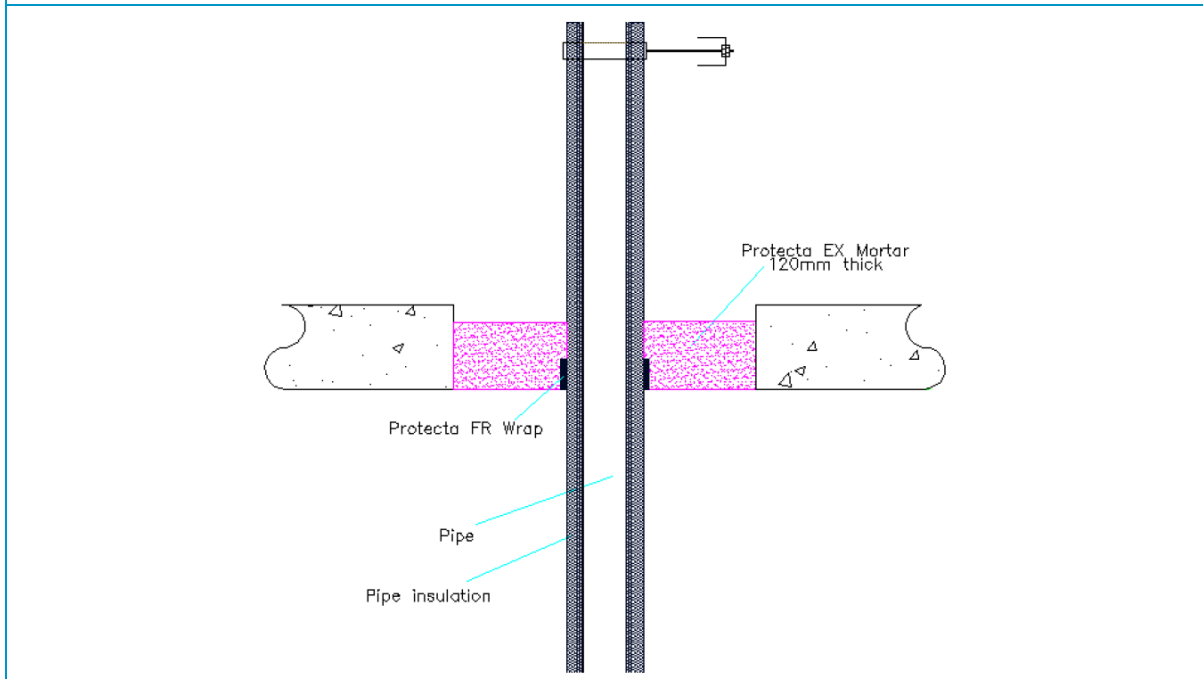
## 6.5 Rigid floor constructions according to section 4.1 2) with floor thickness of minimum 120 mm

### 6.5.1 Pipe penetration seal with 120 mm deep Protecta EX Mortar

**Penetration seal:**

CS (Continuous Sustained) insulated plastic pipes fitted at any position within the aperture (min. separation 30 mm from seal edges and 30 mm from other services), with min. 120 mm Protecta EX Mortar to either surface of the floor or anywhere between. Protecta FR Pipes Wraps are required to be fitted around combustible pipe insulation to the bottom of the seal, as indicated below. Maximum seal size as section 4.1 4).

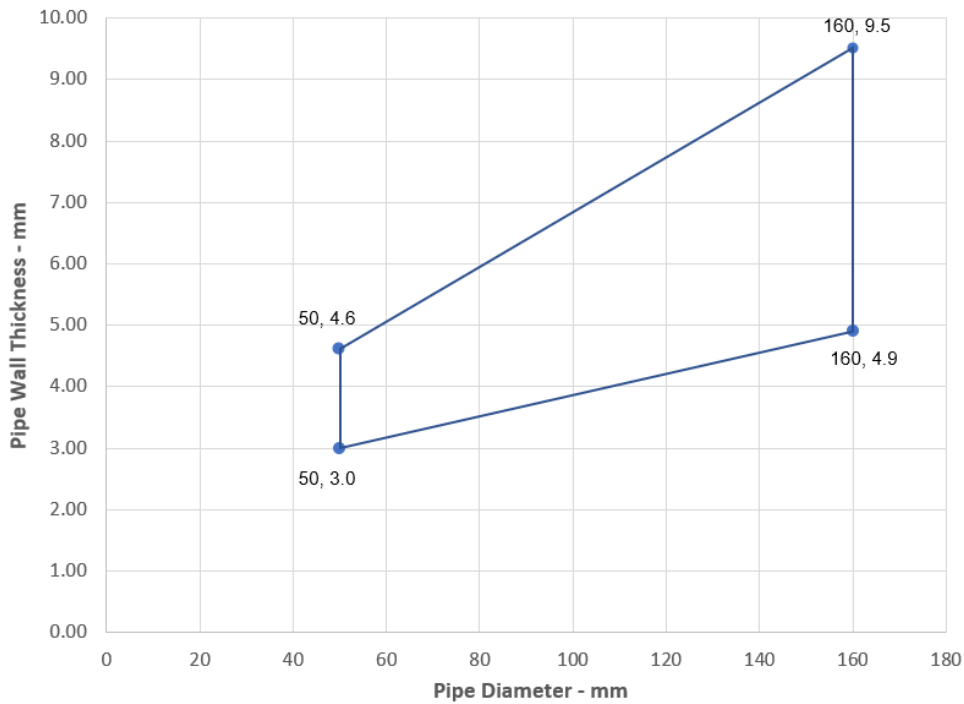
**Construction details:**



**Table 39 Single sided penetration seal with pipes**

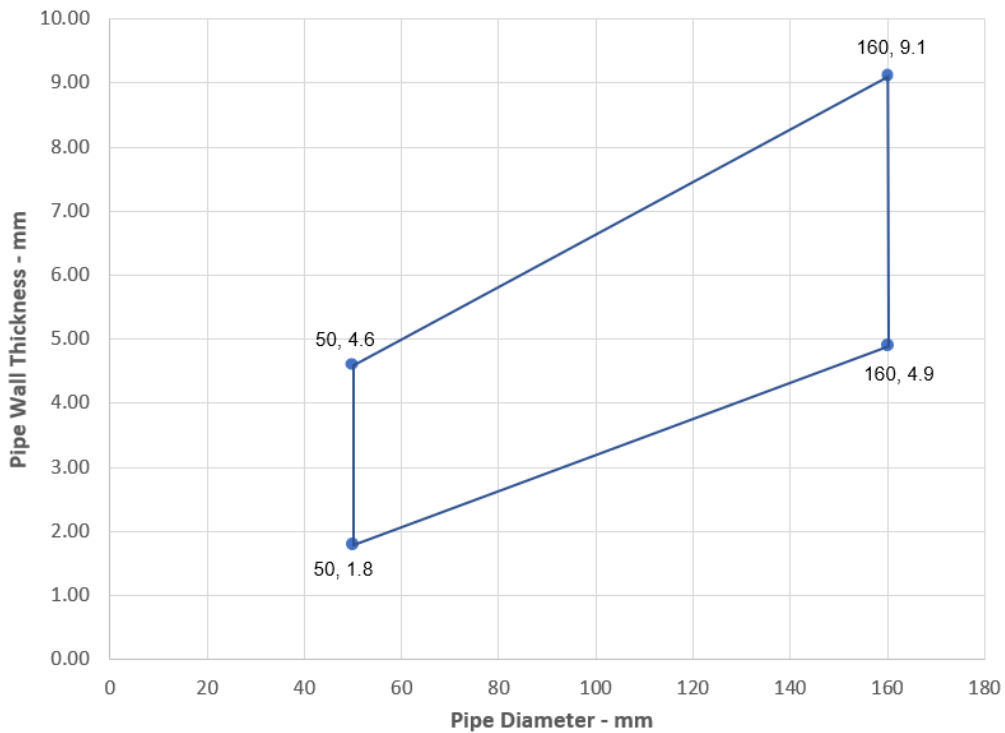
Services	Outer diameter including insulation	Pipe wrap	Pipe insulation	FRL
<b>PE pipes</b>				
Maximum 160 mm diameter pipe*	Maximum 68 mm diameter	50 mm × 3.6 mm (2 × 1.8 layers)	9-50 mm Elastomeric insulation minimum class B-s3,d0 or foil faced phenolic foam insulation	-/240/240 C/C
	Maximum 178 mm diameter	75 mm × 10.8 mm (6 × 1.8 layers)		
	Maximum 260 mm diameter	75 mm × 18.0 mm (10 × 1.8 layers)	-/120/120 C/C	
<b>PP pipes</b>				
Maximum 160 mm diameter pipe*	Maximum 68 mm diameter	50 mm × 3.6 mm (2 × 1.8 layers)	9-50 mm Elastomeric insulation minimum class B-s3,d0 or foil faced phenolic foam insulation	-/240/180 C/C
	Maximum 178 mm diameter	75 mm × 10.8 mm (6 × 1.8 layers)		-/240/240 C/C
	Maximum 260 mm diameter	75 mm × 18.0 mm (10 × 1.8 layers)		-/120/120 C/C
*See below graph for interpolation pipe sizes				

**PE pipes 50-160 mm Diameter with Insulation CS**



**Figure 41 Intermediate pipe wall thicknesses for typical PE pipe with 50 – 160 mm diameters (Continuous sustained insulation)**

**PP pipes 50-160 mm Diameter with Insulation CS**



**Figure 42 Intermediate pipe wall thicknesses for typical PP pipe with 50 – 160 mm diameters (Continuous sustained insulation)**



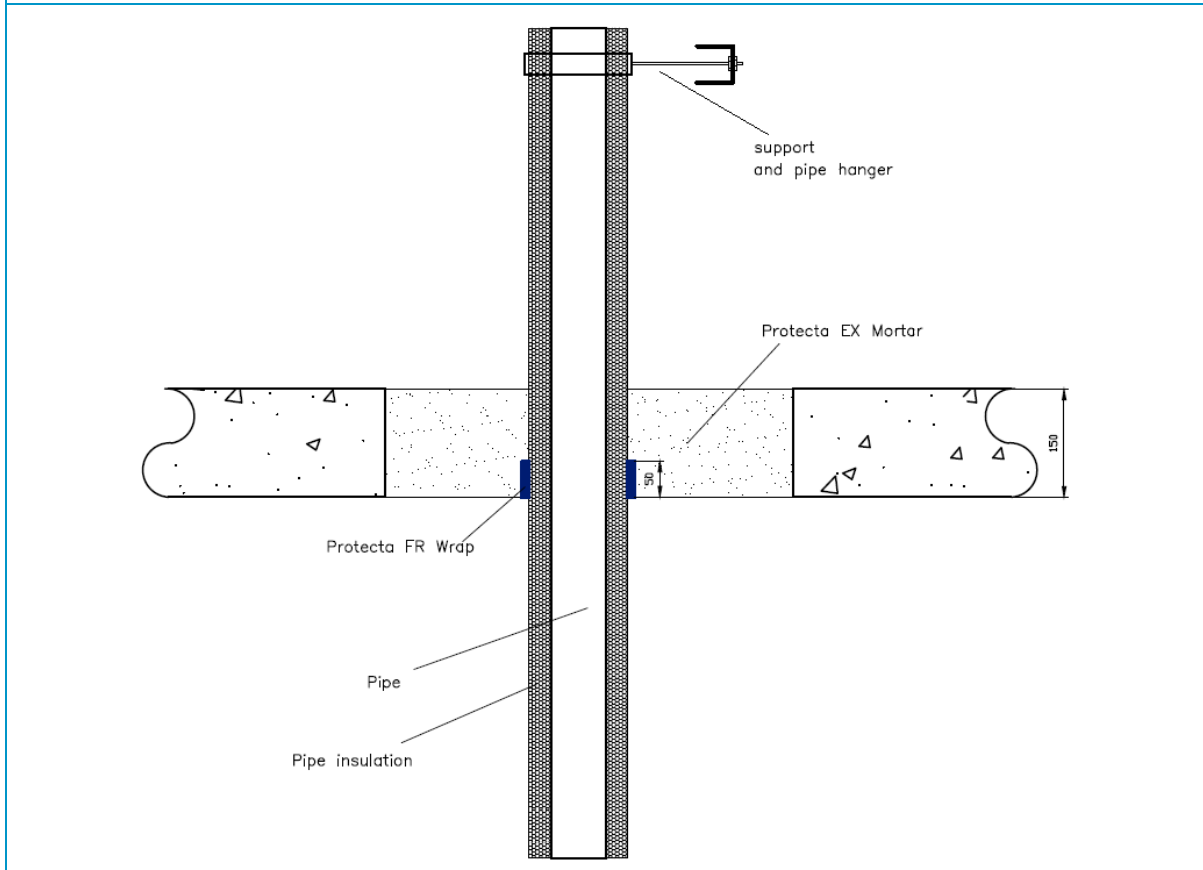
## 6.6 Rigid floor constructions according to section 4.1 2) with floor thickness of minimum 150 mm

### 6.6.1 Pipe penetration seal with 150 mm deep Protecta EX Mortar

**Penetration seal:**

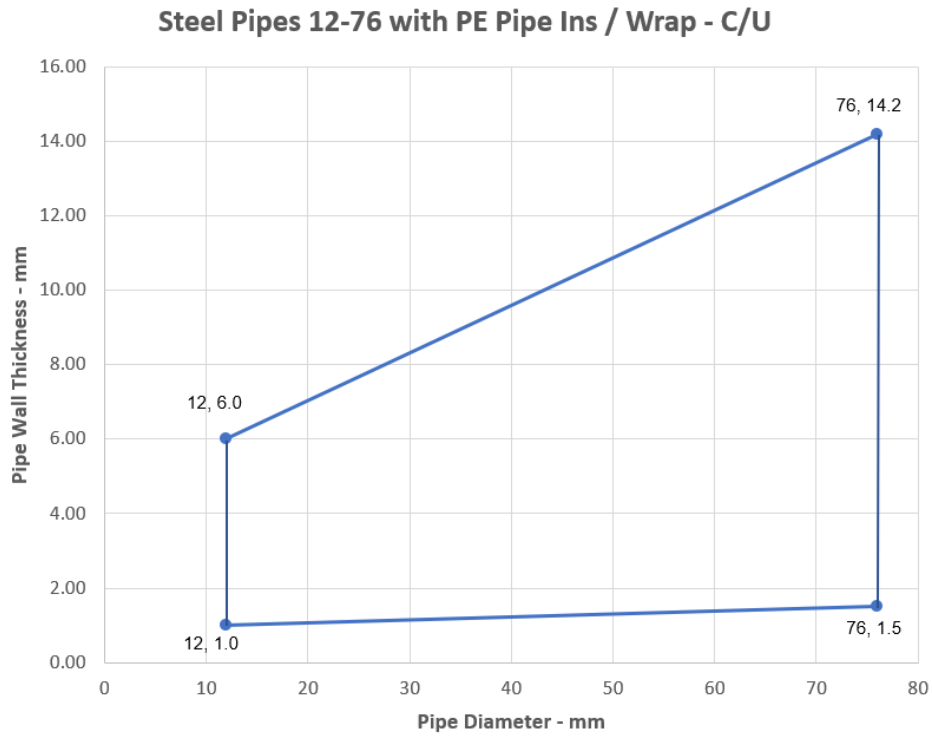
CS (Continuous Sustained) insulated metallic pipes fitted at any position within the aperture (min. separation 30 mm from seal edges and 30 mm from other services), with min. 150 mm Protecta EX Mortar to either surface of the floor or anywhere between. Protecta FR Pipes Wraps are required to be fitted around combustible pipe insulation. Maximum seal size as section 4.1 4).

**Construction details:**



**Table 40 Single side penetration seal with pipes**

Services	Wrap	Insulation	FRL
<b>Mild or stainless steel pipes</b>			
12 mm diameter/ 1.0 mm wall	1 off 50 mm × 1.8 mm Protecta FR Pipe Wrap, fitted at soffit	9 mm PE foam insulation	-/180/180 C/U
Maximum 76 mm diameter/ 1.5-14.2 mm wall*	2 off 50 mm × 1.8 mm Protecta FR Pipe Wrap, fitted at soffit	9-30 mm PE foam insulation	-/180/60 C/U
*See below graph for intermediate sizes			



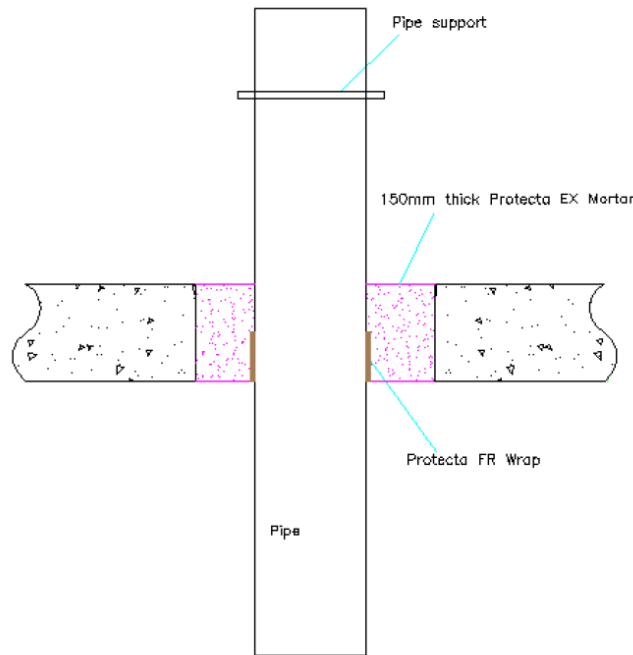
**Figure 43** Intermediate pipe wall thicknesses for typical steel pipes with PE pipe insulation (C/U pipe end conditions)

### 6.6.2 Pipe penetration seal with 150 mm deep Protecta EX Mortar

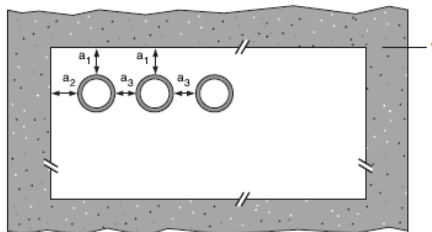
**Penetration seal:**

Plastic pipes fitted at any position within the aperture (min. separation 30 mm from seal edges and from other services), with 150 mm Protecta EX Mortar to either surface of the floor or anywhere between. Protecta FR Pipe Wraps are required to be fitted to the bottom of the seal, as indicated below. Maximum seal size as section 4.1 4).

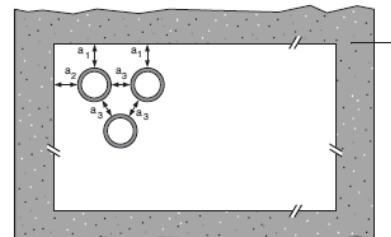
**Construction details:**



**Configuration 1**



**Configuration 2**



**Key**

- 1 Supporting construction
- a1 Pipe / top edge of seal separation
- a2 Pipe / side edge of seal separation
- a3 Pipe / pipe separation

**Table 41 Pipe penetration seal with 150 mm deep Protecta EX Mortar**

Services	Wrap	Permitted configuration for seal separation	FRL
<b>PVC-U pipes</b>			
Up to 40 mm diameter/1.8-3.7 mm wall*	50 mm × 1.8 mm	1 & 2	-/120/120 U/U
Up to 125 mm diameter / 4.8-7.4 mm wall*	50 mm × 7.2 mm		-/60/60 U/U
Up to 160 mm diameter/9.5 mm wall*	75 mm × 7.2 mm		-/120/30 U/U

Services	Wrap	Permitted configuration for seal separation	FRL
<b>PP pipes</b>			
Up to 40 mm diameter/1.8-5.5 mm wall*	50 mm × 1.8 mm	1 & 2	-/120/120 U/U
Up to 125 mm diameter / 11.4 mm wall*	50 mm × 7.2 mm		-/240/240 U/U
Up to 160 mm diameter/14.6 mm wall*	75 mm × 7.2 mm		-/240/240 U/U
<b>PE pipes</b>			
Up to 40 mm diameter/2.4-3.7 mm wall*	50 mm × 1.8 mm	1 & 2	-/240/240 U/U
Up to 110 mm diameter/3.4-10 mm wall*	75 mm × 5.4 mm		-/240/240 U/U
Up to 125 mm diameter / 11.4 mm wall*	50 mm × 7.2 mm		-/240/240 U/U
Up to 160 mm diameter/4.9-14.6 mm wall*	75 mm × 7.2 mm		-/120/120 U/U
*Typical pipe diameters shown, see below graph for intermediate sizes			

PVC-U Pipes - E 60 U/U, EI 30 U/U

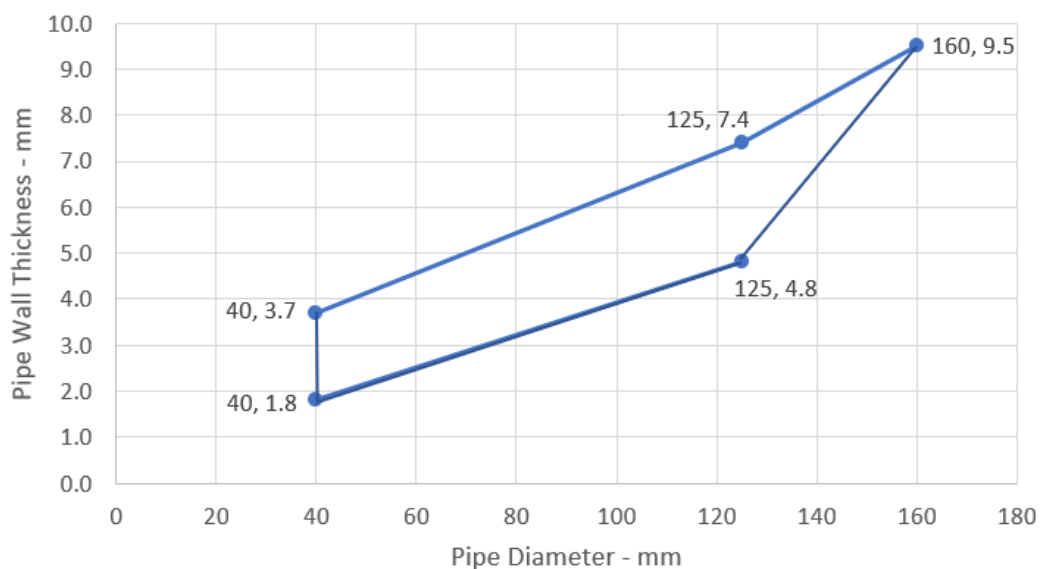


Figure 44 Intermediate pipe wall thicknesses for typical PVC-U pipes

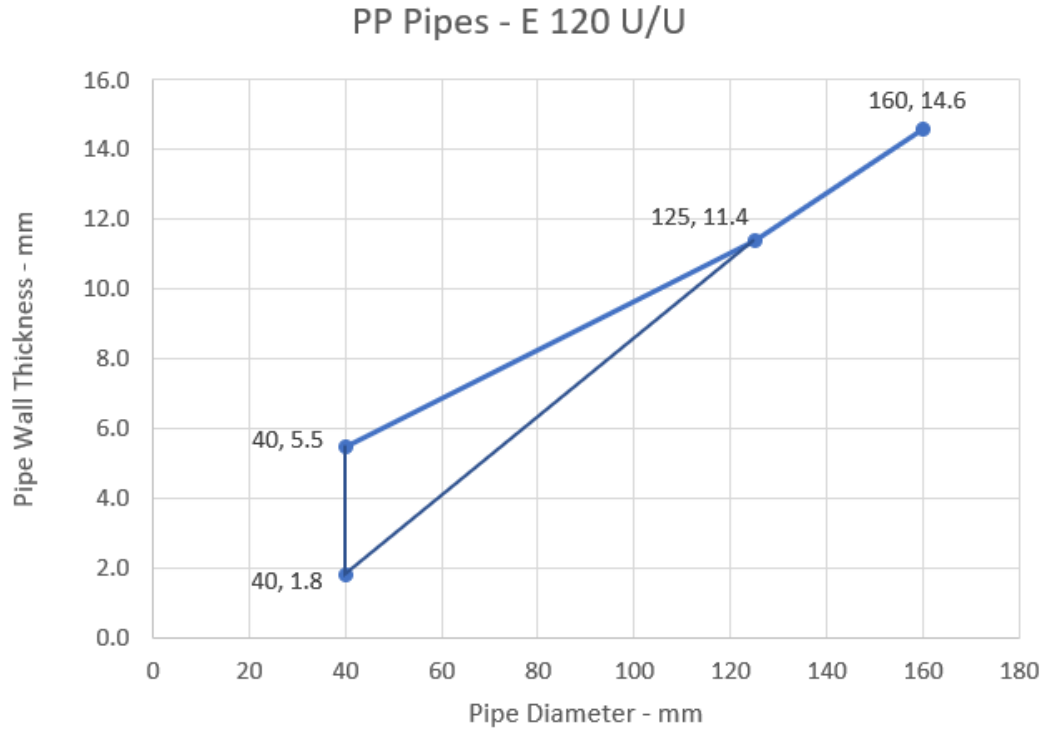


Figure 45 Intermediate pipe wall thicknesses for typical PP pipes

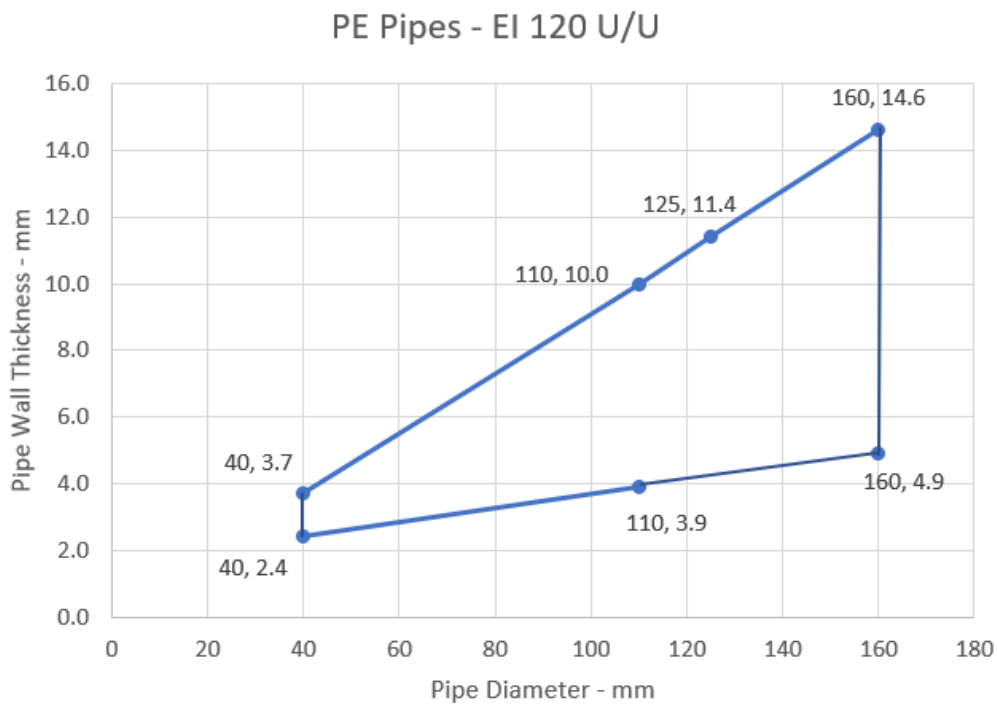


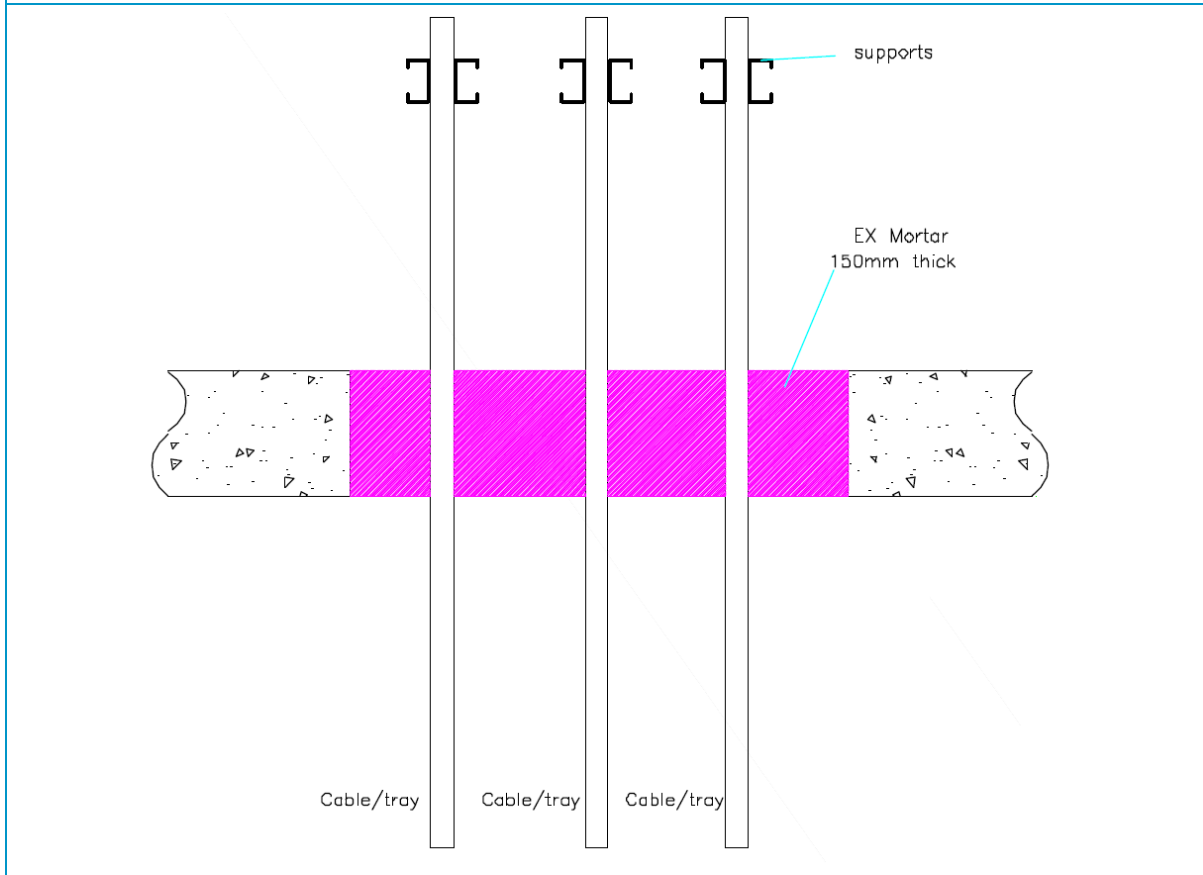
Figure 46 Intermediate pipe wall thicknesses for typical PE pipes

### 6.6.3 Cable penetration seal with 150 mm deep Protecta EX Mortar

**Penetration seal:**

Cables fitted with Protecta EX Mortar to either side of floor. Maximum seal size as section 4.1 4) and minimum separation between cables and the edge of the seal of 30 mm.

**Construction details:**



**Table 42 Single side penetration seal with cables**

Services	Mortar depth	Backing	Insulation	FRL
Blank seals	Min. 150 mm	None	None	-/240/240
Electric cables up to 21 mm diameter, single or in a bundle.				-/240/120
Steel cable trays and ladders up to 500 mm wide				
Electric cables 22-50 mm diameter, single or in a bundle.				-/240/90
Electric cables 51-80 mm diameter, single or in a bundle.				-/90/60
Unsheathed wire up to 24 mm diameter				-/120/120

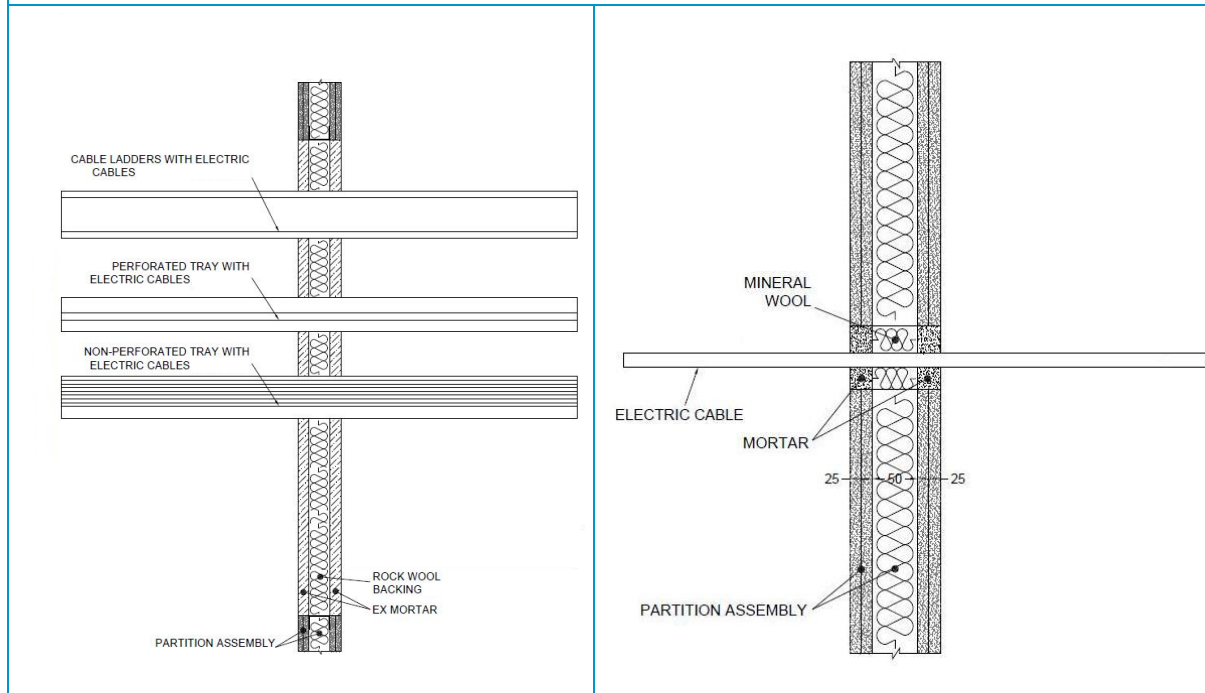
## 6.7 Flexible and rigid wall constructions according to section 4.1 2) with wall thickness of min. 100 mm

### 6.7.1 Cable penetration seal with 25 mm deep Protecta EX Mortar to both faces backed with 50 mm mineral fibre board

#### Penetration seal:

Cables fitted at any position within the aperture (min. separation 25 mm from seal edges), with min. 25 mm Protecta EX Mortar to both sides of the wall, backed with min. 1 x 50 mm or 2 x 25 mm stone wool board min. 150 kg/m<sup>3</sup>.

#### Construction details:



**Table 43 Double side penetration seal with cables**

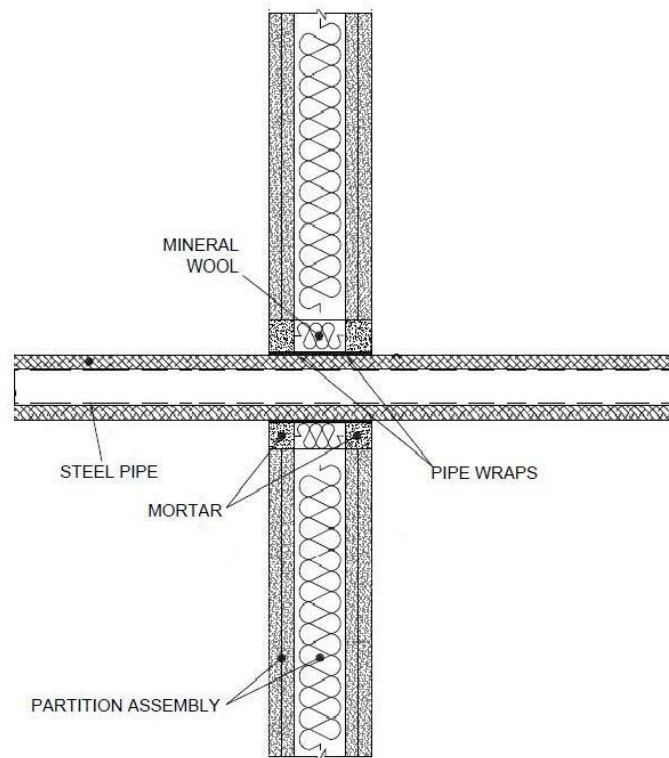
Services	Maximum aperture	FRL
None (blank)	As section 4.1 4)	-/120/120
Single electrical cables up to Ø 21 mm (min.100 separation from other services)		-/120/90
Electrical cables up to Ø 80 mm (single, bundled and on trays)		-/120/60
Steel cable trays & ladders		
Steel conduits up to Ø 16 mm		-/120/60 C/U
Copper conduits up to Ø 16 mm		-/120/45 C/U
Unsheathed wires up to Ø 24 mm		-/120/45
PVC conduits up to Ø 16 mm		-/120/120 C/U, C/C

### 6.7.2 Pipe penetration seal with 25 mm deep Protecta EX Mortar to both faces backed with 50 mm mineral fibre board

**Penetration seal:**

CS (Continuous Sustained) insulated metallic pipes fitted at any position within the aperture (min. separation 30 mm from seal edges), with min. 25 mm Protecta EX Mortar to both sides of the wall, backed with min. 1 × 50 mm or 2 × 25 mm stone wool board min. 150 kg/m<sup>3</sup> or min. 50 mm Protecta EX Mortar to both sides of the wall without backing\*. Protecta FR Pipe wraps are required to be fitted to both faces of the seal.

**Construction details:**



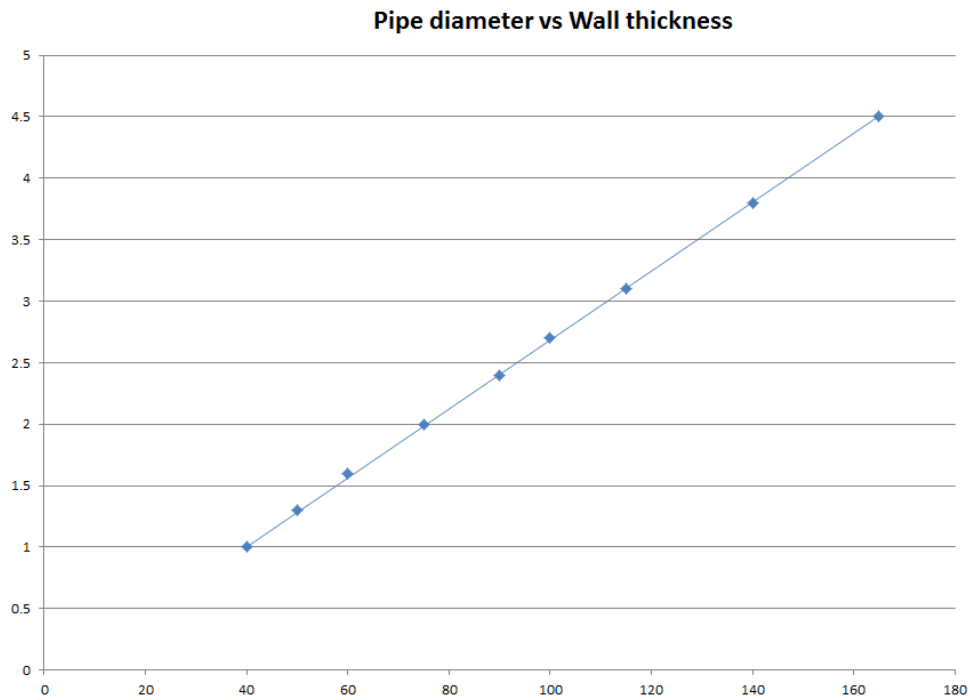
\*Maximum seal size as section 4.1 4))

**Table 44 Double side penetration seal with pipes**

Services	Wrap	Insulation	FRL
<b>Mild or stainless steel pipes</b>			
40 mm diameter/1-14.2 mm wall	2 off 50 mm × 1.8 mm Protecta FR Pipe Wrap, one fitted flush to each face of seal	13 mm Elastomeric insulation minimum class B-s3,d0 or PE Foam insulation	-/120/120 C/U
40 mm diameter/1-14.2 mm wall*			-/120/60 C/U
50 mm diameter/1.3-14.2 mm wall*			
60 mm diameter/1.6-14.2 mm wall*			
75 mm diameter/2-14.2 mm wall*			
90 mm diameter/2.4-14.2 mm wall*			
100 mm diameter/2.7-14.2 mm wall*			
115 mm diameter/3.1-14.2 mm wall*			



Services	Wrap	Insulation	FRL
140 mm diameter/3.8-14.2 mm wall*			
165 mm diameter/ 4.5-14.2 mm wall*			
*Typical pipe diameters shown, see below graph for intermediate sizes			



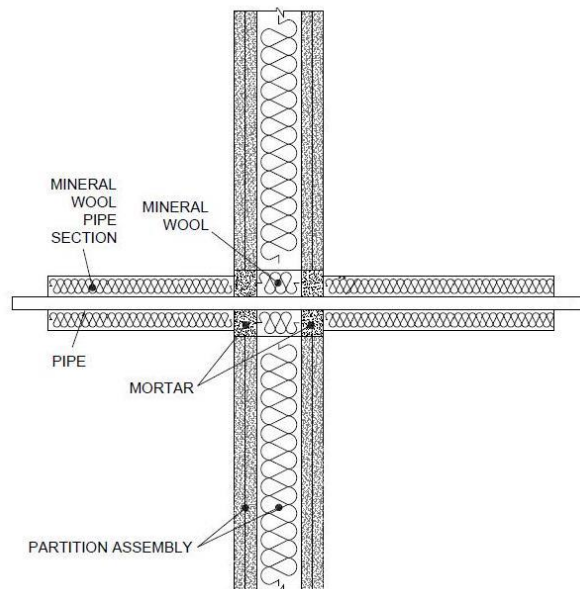
**Figure 47** Intermediate pipe wall thicknesses for typical mild or stainless steel pipes

### 6.7.3 Pipe penetration seal with 25 mm deep Protecta EX Mortar to both faces backed with 50 mm mineral fibre board

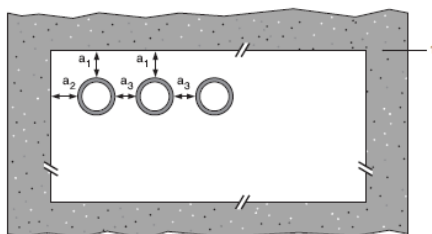
**Penetration seal:**

500 mm (min.)\* LI (Local Interrupted) or CI (Continuous Interrupted) insulated metallic (and composite) pipes fitted at any position within the aperture (min. separation 30 mm from seal edges), with min. 25 mm Protecta EX Mortar to both sides of the wall backed with min. 1 × 50 mm or 2 × 25 mm stone wool board min. 150 kg/m<sup>3</sup>. Maximum seal size as section 4.1 4).

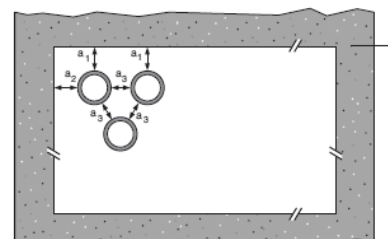
**Construction details:**



**Configuration 1**



**Configuration 2**



**Key**

- 1 Supporting construction
- a1 Pipe / top edge of seal separation
- a2 Pipe / side edge of seal separation
- a3 Pipe / pipe separation

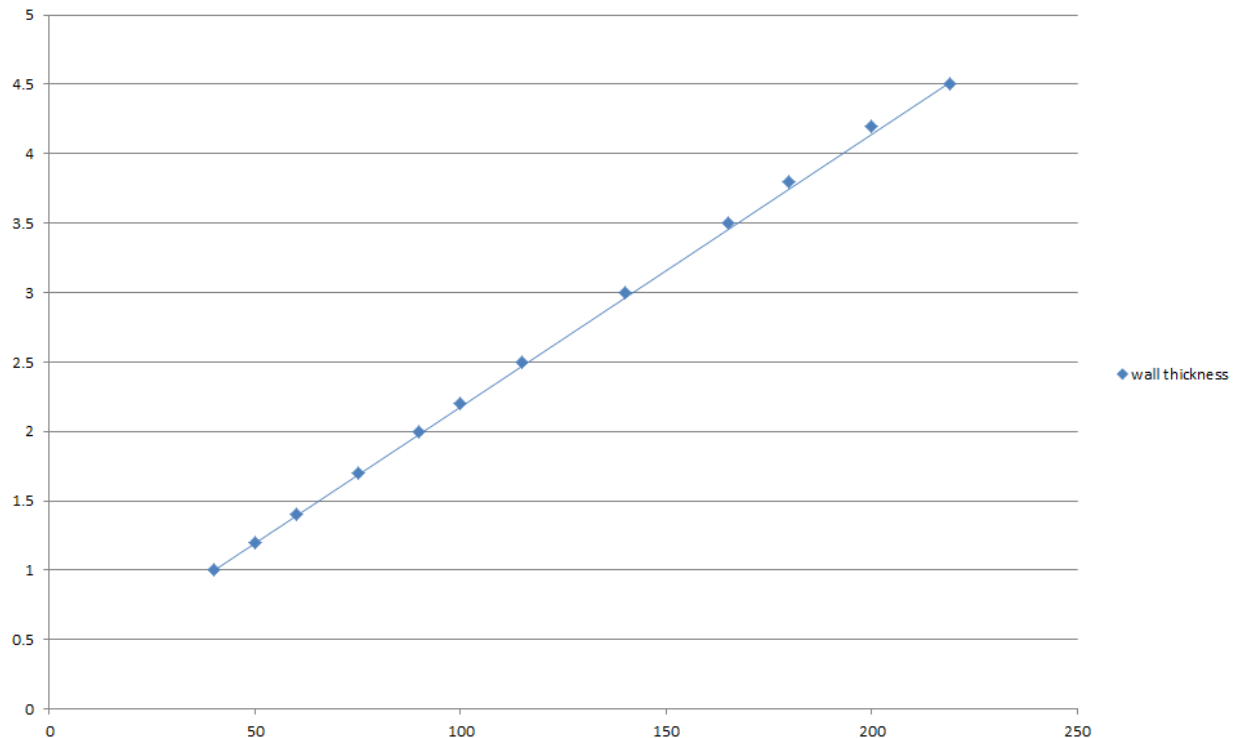
**Table 45 Double side penetration seal with pipes**

Services	Insulation	FRL
Copper or steel pipes up to 54 mm diameter/1-14.2 mm wall	Min. 20 mm stone wool min. 80 kg/m <sup>3</sup>	-/120/120 C/C
Alupex composite pipe 75 mm diameter/7.5 mm wall	600 mm length of 25 mm Protecta Mineral Fibre BIO	-/60/60 U/U, U/C, C/U, C/C

**Table 46 Double side penetration seal with pipes**

Services	Insulation, minimum thickness and density	FRL
<b>Mild or stainless steel pipes</b>		
40 mm diameter/1-14.2 mm wall	20 mm stone wool 80 kg/m <sup>3</sup>	-/120/120 C/U
40 mm diameter/1-14.2 mm wall*	30 mm stone wool 80 kg/m <sup>3</sup>	-/120/90 C/U
50 mm diameter/1.2-14.2 mm wall*		
60 mm diameter/1.4-14.2 mm wall*		
75 mm diameter/1.7-14.2 mm wall*		
90 mm diameter/2-14.2 mm wall*		
100 mm diameter/2.2-14.2 mm wall*		
115 mm diameter/2.5-14.2 mm wall*		
140 mm diameter/3-14.2 mm wall*		
165 mm diameter/3.5-14.2 mm wall*		
180 mm diameter/3.8-14.2 mm wall*		
200 mm diameter/4.2-14.2 mm wall*		
219 mm diameter/4.5-14.2 mm wall*		
*Typical pipe diameters shown, see below graph for intermediate sizes		

**Pipe diameter vs Wall thickness**



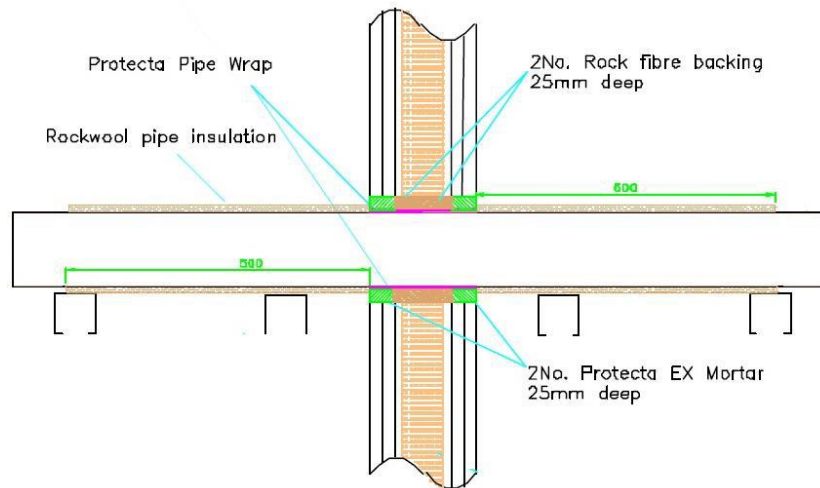
**Figure 48 Intermediate pipe wall thicknesses for typical mild or stainless steel pipes**

### 6.7.4 Pipe penetration seal with 25 mm deep Protecta EX Mortar to both faces backed with 50 mm mineral fibre board

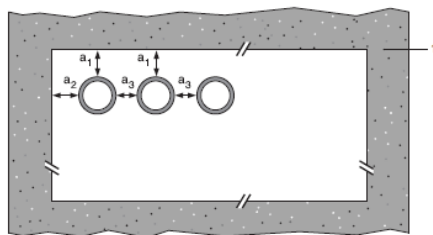
**Penetration seal:**

500 mm (min.)\* LI (Local Interrupted) or CI (Continuous Interrupted) insulated metallic (and composite) pipes fitted at any position within the aperture (min. separation 30 mm from seal edges), with min. 25 mm Protecta EX Mortar to both sides of the wall backed with min. 1 × 50 mm or 2 × 25 mm stone wool board min. 150 kg/m<sup>3</sup>. Maximum seal size as section 4.1 4).

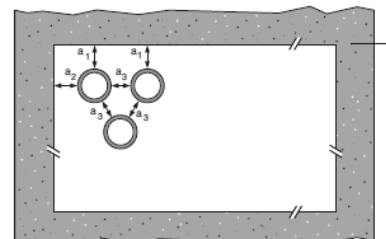
**Construction details:**



**Configuration 1**



**Configuration 2**



**Key**

- 1 Supporting construction
- a1 Pipe / top edge of seal separation
- a2 Pipe / side edge of seal separation
- a3 Pipe / pipe separation

**Table 47 Double side penetration seal with pipes**

Services	Insulation	FRL
<b>Alupex pipes</b>		
16 mm diameter/2.25 mm wall	Minimum 20 mm stone wool, minimum 80 kg/m <sup>3</sup>	-/120/120 C/C
20 mm diameter/2.5 mm wall		
26 mm diameter/3 mm wall		
32 mm diameter/3 mm wall		
40 mm diameter/3.5 mm wall		
50 mm diameter/4 mm wall		
63 mm diameter/4.5 mm wall		
75 mm diameter/4.7 mm wall		
*Typical pipe diameters shown, see below graph for intermediate sizes		

### Pipe diameter vs Wall thickness - Alupex Pipes with Insulation LI

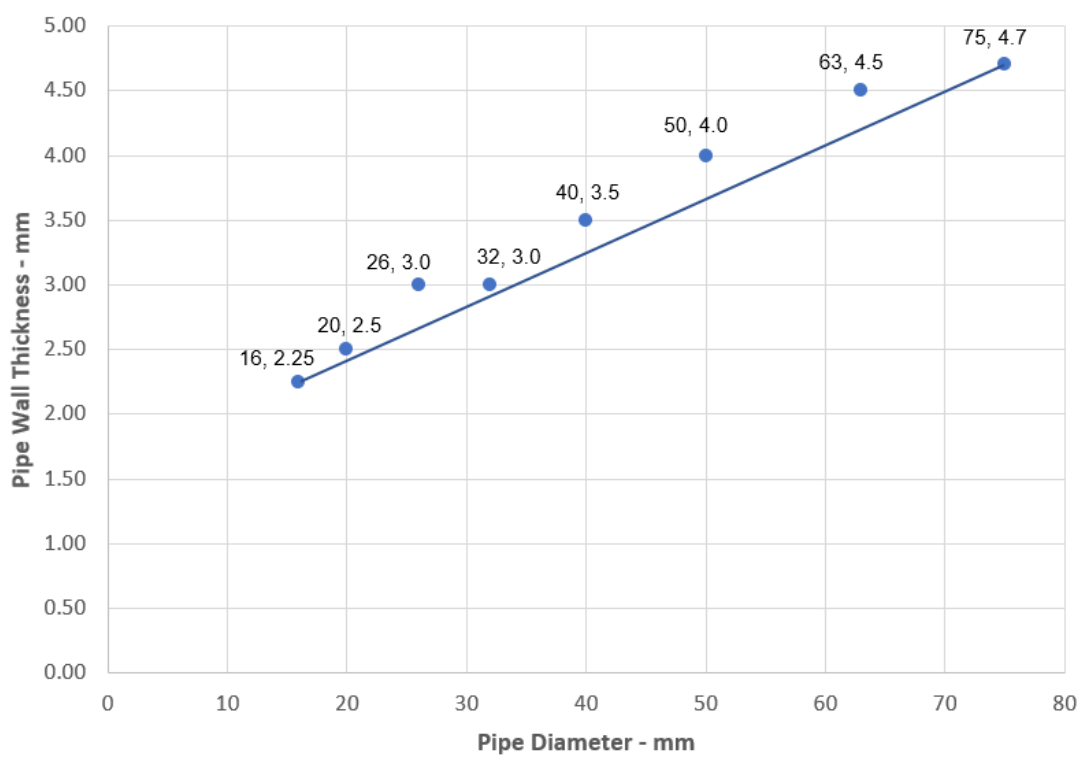


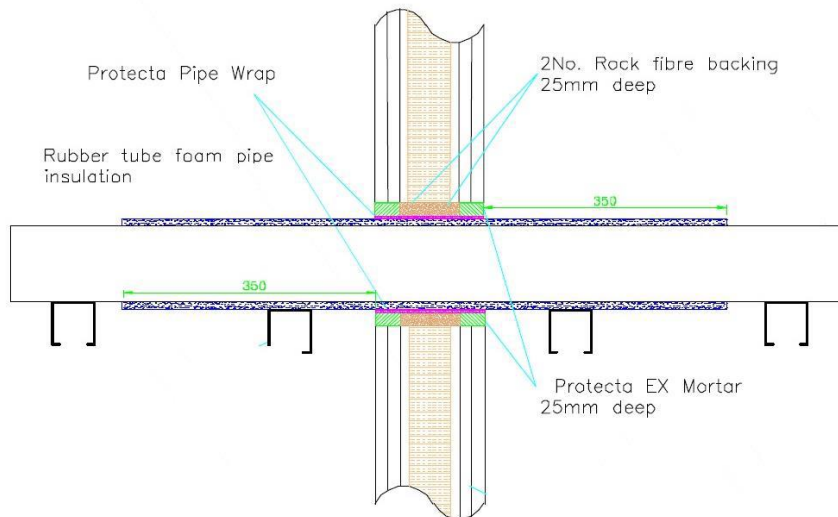
Figure 49 Intermediate pipe wall thicknesses for typical Alupex pipes

### 6.7.5 Pipe penetration seal with 25 mm deep Protecta EX Mortar to both faces backed with 50 mm mineral fibre board

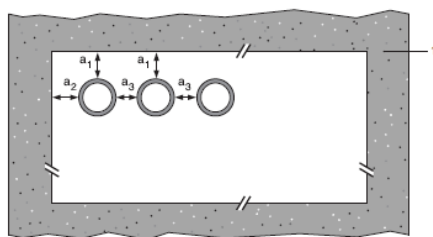
**Penetration seal:**

CS (Continuous Sustained) insulated metallic and composite pipes fitted at any position within the aperture (min. separation 25 mm from seal edges), with min. 25 mm Protecta EX Mortar to both sides of the wall, backed with min. 25 mm stone wool min. 150 kg/m<sup>3</sup>. Protecta FR Pipe wraps are required to be fitted to both faces of the seal. Maximum seal size as section 4.1 4).

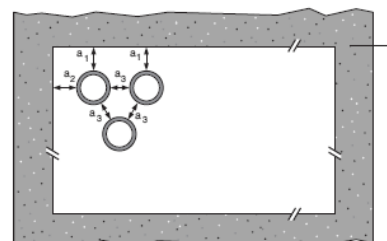
**Construction details:**



**Configuration 1**



**Configuration 2**



**Key**

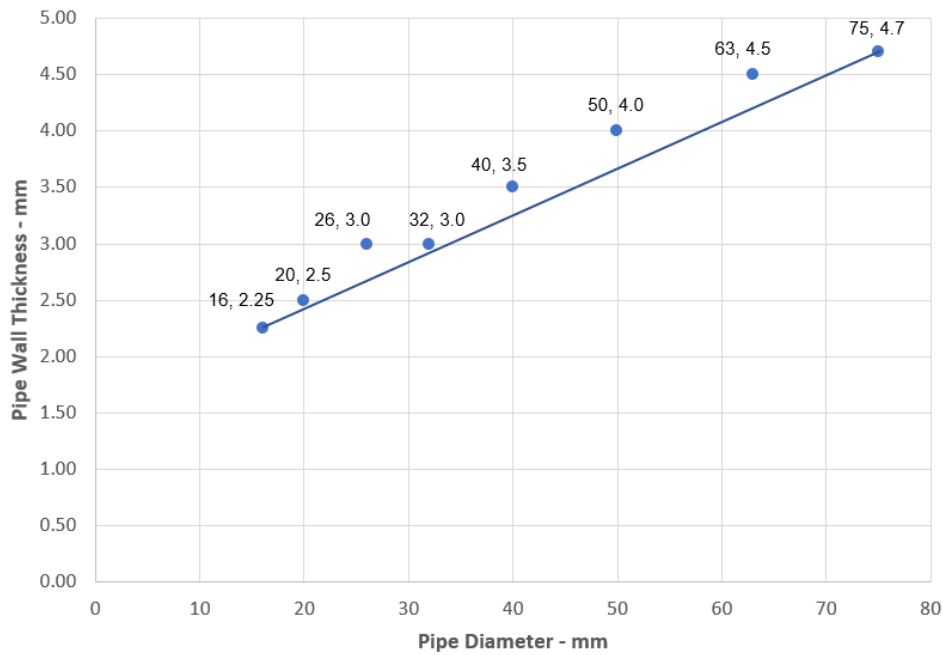
- 1 Supporting construction
- a1 Pipe / top edge of seal separation
- a2 Pipe / side edge of seal separation
- a3 Pipe / pipe separation

**Table 48 Double side penetration seal with pipes**

Services	Wrap	Insulation	FRL
<b>Copper and steel pipes</b>			
12-54 mm diameter/1-1.2 mm wall	50 mm × 3.6 mm Protecta FR Pipe Wrap fitted to both sides of the seal	9-25 mm Elastomeric insulation minimum class B-s3, d0 or PE Foam insulation	-/120/120 C/C
<b>Alupex pipes</b>			
16 mm diameter/2.25 mm wall	50 mm × 3.6 mm Protecta FR Pipe Wrap fitted to both sides of the seal	9-25 mm Elastomeric insulation minimum class B-s3, d0 or PE Foam insulation	-/120/120 C/C
20 mm diameter/2.5 mm wall			
26 mm diameter/3 mm wall			
32 mm diameter/3 mm wall			

Services	Wrap	Insulation	FRL
40 mm diameter/3.5 mm wall			
50 mm diameter/4 mm wall			
63 mm diameter/4.5 mm wall			
75 mm diameter/4.7 mm wall			

**Pipe diameter vs Wall thickness - Alupex Pipes with Insulation CS**



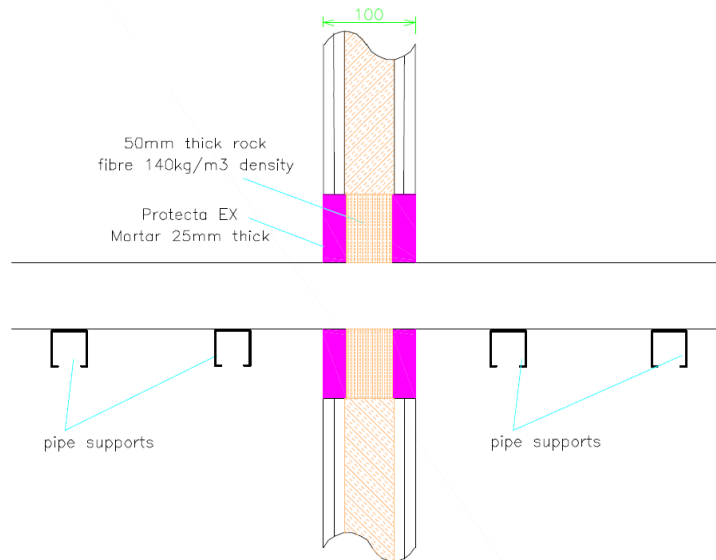
**Figure 50 Intermediate pipe wall thicknesses for typical Alupex pipes**

### 6.7.6 Pipe penetration seal with 25 mm deep Protecta EX Mortar to both faces backed with 50 mm mineral fibre board

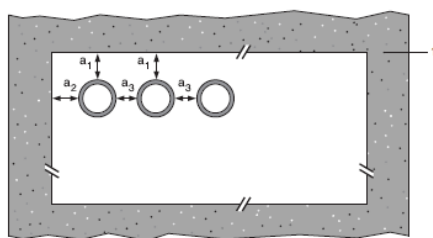
**Penetration seal:**

Combustible pipes sealed with Protecta EX Mortar, to both sides of the wall, backed with stone wool board min. 140 kg/m<sup>3</sup>. Minimum separation between pipes of 30 mm (a<sub>3</sub>) and from seal edges 30 mm (a<sub>1</sub> & a<sub>2</sub>). Maximum seal size as section 4.1 4).

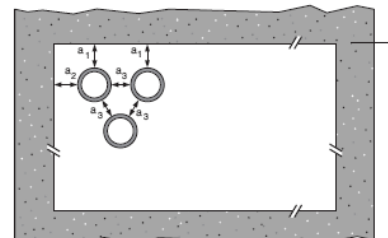
**Construction details:**



**Configuration 1**



**Configuration 2**



**Key**

- 1 Supporting construction
- a1 Pipe / top edge of seal separation
- a2 Pipe / side edge of seal separation
- a3 Pipe / pipe separation

**Table 49 Double side penetration seal with pipes**

Services	Seal Depth	Permitted configuration for seal separation	FRL
<b>PVC-U pipes</b>			
Diameter up to 32 mm, wall thickness 1.6 – 2.4 mm	Min. 25 mm	1 & 2 between all specified pipes	-/120/120 U/C, C/C
<b>PE pipes</b>			
Diameter up to 32 mm, wall thickness 1.8 – 3.0 mm	Min. 25 mm	1 & 2 between all specified pipes	-/120/120 U/C, C/C
<b>PP pipes</b>			
Diameter up to 32 mm, wall thickness 1.9 – 4.4 mm	Min. 25 mm	1 & 2 between all specified pipes	-/120/120 U/C, C/C

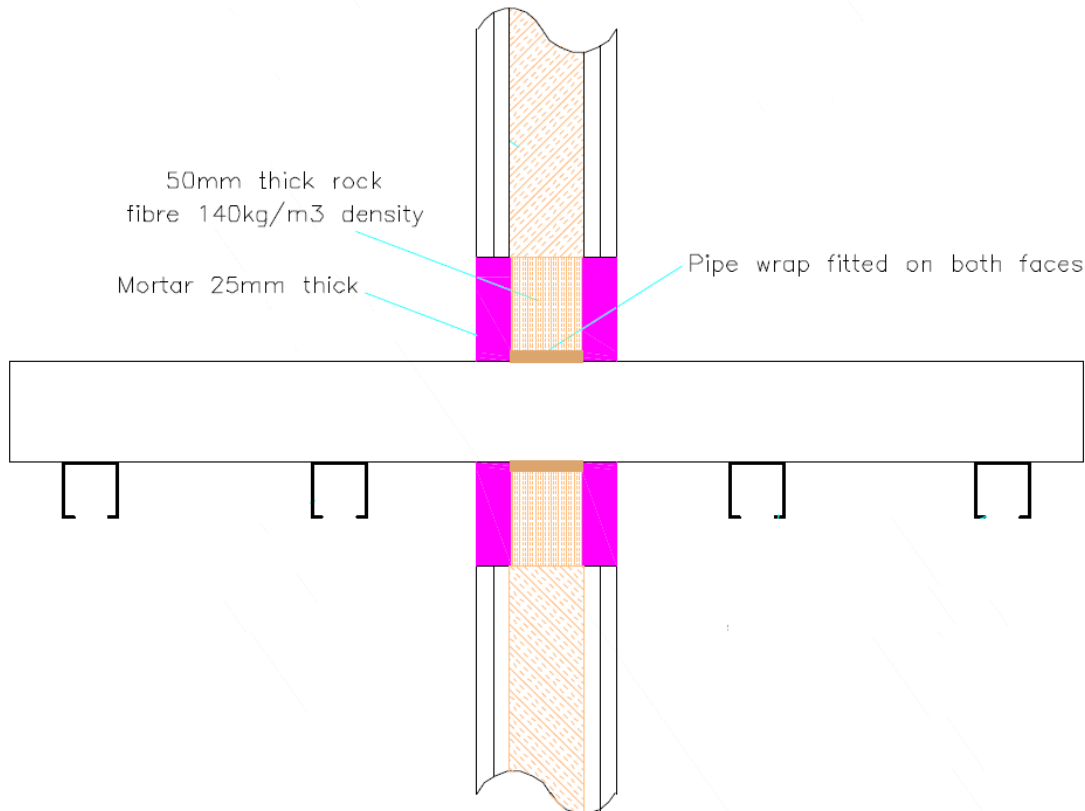


### 6.7.7 Pipe penetration seal with 25 mm deep Protecta EX Mortar to both faces backed with 50 mm mineral fibre board

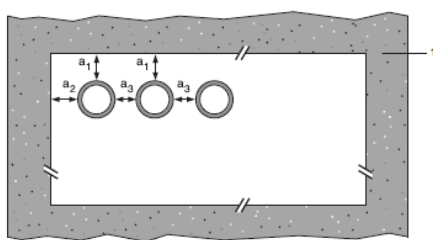
**Penetration seal:**

Combustible pipes sealed with Protecta FR Pipe Wrap, installed into Protecta EX Mortar seals. Minimum separation between penetration seals and seal edges of 30 mm. Minimum seal size as section 4.1 4)

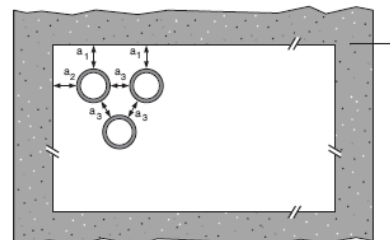
**Construction details:**



**Configuration 1**



**Configuration 2**



**Key**

- 1 Supporting construction
- a1 Pipe / top edge of seal separation
- a2 Pipe / side edge of seal separation
- a3 Pipe / pipe separation

\*Partition wall must incorporate a full fill core insulation of Stonewool (35 kg/m³ density)

**Table 50 Double side penetration seal with pipes**

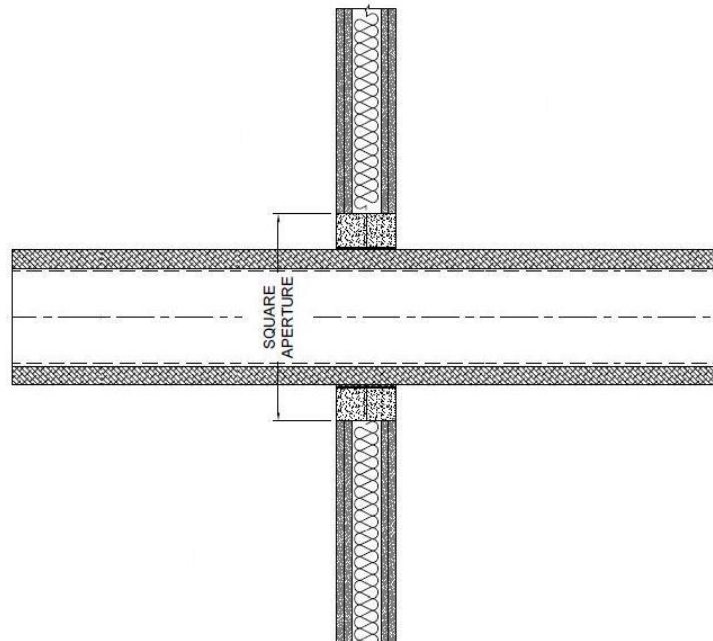
Services	Wraps (both sides)	Permitted configuration for seal separation	FRL
<b>PVC-U pipes</b>			
Diameter up to 40 mm, wall thickness 3.0 – 4.3 mm	50 mm × 1.8 mm (1 layer)	1 & 2 between PVC-U/PVC-C, PE/ABS/SAN+PVC and PP pipes in any combination	-/120/60 U/C, C/C
Diameter up to 110 mm, wall thickness 2.7 - 6.6 mm	50 mm × 3.6 mm (2 × 1.8 layer)		-/120/90 U/C, C/C
Diameter up to 125 mm, wall thickness 3.7 – 7.4 mm	50 mm × 5.4 mm (3 × 1.8 layer)		-/120/120 U/C, C/C
Diameter up to 160 mm, wall thickness 3.2 - 9.5 mm	50 mm × 7.2 mm (4 × 1.8 layer)		-/60/60 U/C, C/C
<b>PE pipes</b>			
Diameter up to 40 mm, wall thickness 3.2 – 3.7 mm	50 mm × 1.8 mm (1 layer)	1 & 2 between PVC-U/PVC-C, PE/ABS/SAN+PVC and PP pipes in any combination	-/120/120 U/C, C/C
Diameter up to 110 mm, wall thickness 4.2 – 10 mm	50 mm × 3.6 mm (2 × 1.8 layer)		-/60/60 U/C, C/C
Diameter up to 125 mm, wall thickness 12.0 mm	50 mm × 5.4 mm (3 × 1.8 layer)		-/120/120 U/C, C/C
Diameter up to 160 mm, wall thickness 4.9 - 12.0 mm	50 mm × 7.2 mm (4 × 1.8 layer)		-/120/120 U/C, C/C
Diameter up to 160 mm, wall thickness 12.0 mm			-/90/90 U/C, C/C
<b>PP pipes</b>			
Diameter up to 40 mm, wall thickness 4.0 – 5.5 mm	50 mm × 1.8 mm (1 layer)	1 & 2 between PVC-U/PVC-C, PE/ABS/SAN+PVC and PP pipes in any combination	-/120/120 U/C, C/C
Diameter up to 110 mm, wall thickness 6.6 mm	50 mm × 3.6 mm (2 × 1.8 layer)		-/120/90 U/C, C/C
Diameter up to 125 mm, wall thickness 17.1 mm	50 mm × 5.4 mm (3 × 1.8 layer)		-/120/90 U/C, C/C
Diameter up to 160 mm, wall thickness 4.0 – 21.9 mm	50 mm × 7.2 mm (4 × 1.8 layer)		-/120/120 U/C, C/C
Diameter up to 160 mm, wall thickness 21.9 mm			-/60/60 U/C, C/C

### 6.7.8 Pipe penetration seal with 50 mm deep Protecta EX Mortar to both faces

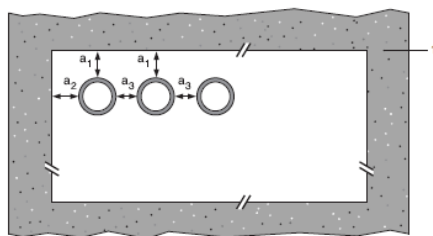
**Penetration seal:**

CS (Continuous Sustained) insulated metallic pipes fitted at any position within the aperture (min. separation 30 mm from seal edges), min. 50 mm Protecta EX Mortar to both sides of the wall without backing\*. Protecta FR Pipe wraps are required to be fitted to both faces of the seal.

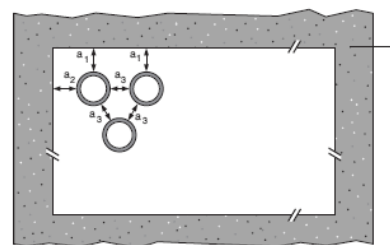
**Construction details:**



**Configuration 1**



**Configuration 2**



**Key**

- 1 Supporting construction
- a1 Pipe / top edge of seal separation
- a2 Pipe / side edge of seal separation
- a3 Pipe / pipe separation

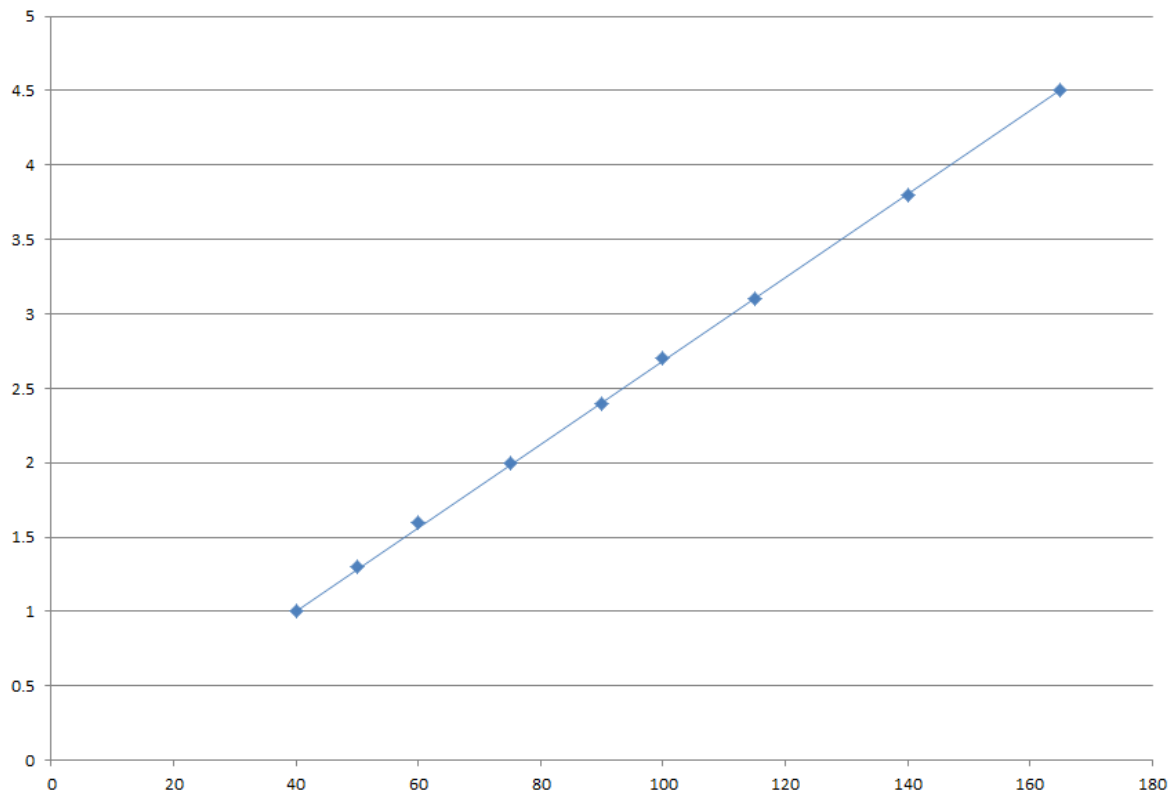
\*Maximum seal size as section 4.1 4)

**Table 51 Double side penetration seal with pipes**

Services	Wrap	Insulation	FRL
<b>Mild or stainless steel pipes</b>			
40 mm diameter/1-14.2 mm wall*	2 off 50 mm × 3.6 mm Protecta FR Pipe Wrap, one fitted flush to each face of seal	13 - 32 mm Elastomeric insulation minimum class B-s3,d0 or PE Foam insulation	-/120/60 C/U
50 mm diameter/1.3-14.2 mm wall*			
60 mm diameter/1.6-14.2 mm wall*			
75 mm diameter/2-14.2 mm wall*			
90 mm diameter/2.4-14.2 mm wall*			

Services	Wrap	Insulation	FRL
100 mm diameter/2.7-14.2 mm wall*			
115 mm diameter/3.1-14.2 mm wall*			
140 mm diameter/3.8-14.2 mm wall*			
165 mm diameter/ 4.5-14.2 mm wall*			
*Typical pipe diameters shown, see below graph for intermediate sizes			

**Pipe diameter vs Wall thickness**



**Figure 51 Intermediate pipe wall thicknesses for typical steel pipes**

## 7. Assessment 3 – Assessment of specific variations

### 7.1 Description of variation

It is proposed that the separating elements are varied as follows:

- Increase in aperture size for fire seals filled with Protecta Ex mortar
- Test results from floors as applicable to walls.
- The plasterboard wall partition assessed shall include the option of lining with two layers of minimum 13 mm thick fire grade plasterboard that has otherwise been tested or assessed as a wall to achieve a FRL -/120/120 on each side of steel or timber framed wall.
- Applying test results obtained to masonry, AAC or concrete walls and bare rigid walls having minimum thickness of 75 mm.
- Wall thickness is reduced from 150 mm to 100 mm for section 6.3.5 and floor thickness is reduced from 150 mm as tested to 100 mm for assessed systems in sections 6.4.5 and 6.4.7.

It is proposed that the integrity rating achieved for insulated pipes can be applied to uninsulated pipes as shown in sections 6.3.3, 6.3.8, 6.4.2 and 6.4.6.

### 7.2 Methodology

The method of assessment used is summarised in Table 52.

**Table 52 Method of assessment**

Assessment method	
Level of complexity	Complex assessment
Type of assessment	Qualitative / Comparative

### 7.3 Assessment

#### 7.3.1 Increase in aperture size for fire seals filled with Protecta Ex mortar

It is proposed that the system Protecta EX Mortar may be used to seal apertures in the separating element up to 2400 mm wide by 1200 mm high in a wall, and 2400 mm by 1200 mm in a floor. The additional sizes that are permitted in floors are:

Width (mm)	Length (mm)
1100	2900
1000	4000
≤ 800	∞ (infinite)

The maximum aperture size tested with Protecta Ex Mortar is 2400 mm long by 1200 mm wide – in specimen A of WF 375797. Considering the plan dimensions of the mortar-filled aperture, the aspect ratio is 2:1 which indicates that it can be considered as a one-way slab in which the bending is primarily about the long axis. Provided that the dimensions of the aperture are increased so that the aspect ratio is equal to or greater than 2:1, the Protecta EX mortar will act as a one-way slab with the same load paths as the tested blank seal. This means that all loads applied onto the aperture will be transferred along the same supporting edges (long edges) as that of the tested system and so the mortar is not expected to detach from the edges and will remain in place. Therefore, the integrity of the seal is not expected to be detrimentally affected with the proposed increase in dimensions.

#### 7.3.2 Applicability of test results from floors to walls

Due to the increased furnace pressure requirement for the floor orientation and the tendency for gravity to cause a cave-in effect to the slab and mortar in this orientation, it is considered that test results obtained from horizontal separating elements can be applied to less onerous vertical wall

separating elements of the same thickness as the tested Protecta EX mortar depth, which is minimum 100 mm.

### 7.3.3 Variation to plasterboard lined wall

It is proposed that the plasterboard wall partition tested in the referenced tests shall include the option of lining with two layers of minimum 13 mm thick fire grade plasterboard that has otherwise been tested or assessed as a wall to achieve an FRL of -/120/120 on each side of steel or timber framed wall.

### 7.3.4 Applicability to masonry, AAC or concrete walls

AS 1530.4:2014 Clause 10.12.2 (c), allows the application of test results obtained in plasterboard-lined partitions to be applied to solid or hollow masonry or normal weight concrete walls of the same or greater thickness.

### 7.3.5 Variation to floor thickness

It is proposed that the construction is similar to the system showed in sections 6.3.5, 6.4.5 and 6.4.7 subject to the following:

Wall thickness is reduced from 150 mm to 100 mm for section 6.3.5 and floor thickness is reduced from 150 mm as tested to 100 mm for assessed systems in sections 6.4.5 and 6.4.7.

Upon closer inspection of test specimens consisting of pipes penetrating a 150 mm thick floor slab sealed with 100 mm Protecta EX Mortar, it is identified that the temperature rise measured by the thermocouple placed on the Protecta EX Mortar did not exceed 100°C for the duration of the test, which gives confidence in the sealing and fire protection provided by the Protecta EX Mortar.

It is proposed that the floor thickness is reduced to 100 mm, maintaining the depth of applied Protecta EX Mortar at 100 mm (full depth of floor slab). Since, despite the reduction in floor thickness, the depth of the Protecta EX Mortar is maintained at 100 mm, the temperature measured on the seal is also expected to be maintained at less than 100°C for the time of the test duration.

It is also proposed that, in 100 mm thick floor slabs, the mortar is installed to a depth of 50 mm on 50 mm deep stonewool with minimum density of 150 kg/m<sup>3</sup>. The above discussion can be applied to this system as long as the total depth of the mortar and stonewool backing is maintained at minimum 100 mm.

However, the nominated FRL shall be governed by the FRL of the flooring system provided that it has been tested or assessed by others to achieve that FRL.

Therefore, it is considered that the proposed construction will not introduce any detrimental effect to the integrity and insulation performance of the systems, and hence can be positively assessed.

### 7.3.6 Applicability of results to uninsulated pipes

It is proposed that the integrity rating achieved for insulated pipes is applied to uninsulated pipes as shown in sections 6.3.3, 6.3.8, 6.4.2 and 6.4.6.

As per AS 1530.4:2014, a specimen shall be deemed to have failed the integrity criterion in when any of the following occur:

- Sustained flaming for 10 seconds
- A gap form that allows the passage of hot gases to the unexposed face and ignite the cotton pad when applied for up to 30 seconds
- A gap forms that allows the penetration of a 25 mm gap gauge anywhere on the specimen
- A gap forms that allows a 6 mm × 150 mm gap gauge to penetrate the specimen (anywhere on the specimen).

Upon closer inspection of the tested specimens, it was observed that the above systems were able to maintain integrity performance for the duration of the test with no significant observations on cracks or gaps forming around the penetration on the unexposed side that could have promoted an integrity failure. Moreover, it is acknowledged that the insulation provided on the metallic and composite pipes

is for insulation rating purposes only as it was interrupted and did not continue through the penetration.

Therefore, it is established that the insulation around the pipes has no bearing on the fire integrity rating of the system and assuming that the insulation rating is zero, removing the insulation on the pipe systems will not cause any detrimental effect to the integrity rating of the pipe system. This variation can therefore be positively assessed.

### 7.3.7 Applicability in both walls and floors

- It was confirmed that the tested Polyethylene pipes were PE100 which as confirmed by report sponsor and pipe manufacturer is similar to HDPE pipes. Therefore, the FRLs shown for PE pipes in section 6 are applicable to HDPE pipes.
- Test results for cables remain valid if the diameter of a single cable is reduced and/or number of cables in a bunch is reduced provided that overall diameter of the bunch of any individual cable is not greater than tested.

The test results obtained with standard configuration covers all types of insulated cables with copper or aluminium conductors, fibre optic cables and bundled communication cables, except hollow cables.

- Results obtained from tests where the supports pass through the seal are applicable to those situations where the support is not continued but not vice versa
- The test results obtained using standard configuration for cable penetration systems are valid for:
  - All type of steel cable trays and ladders
  - Any penetration size equal or smaller than that tested, provided the total amount of cross sections of the cables (core and insulation) does not exceed 60% of the penetration.
- Support of services in walls and floors must be maintained as per AS 1530.4:2014 and AS 4072.1:2005 requirements.

## 8. Validity

Warringtonfire Australia does not endorse the tested or assessed product in any way. The conclusions of this assessment may be used to directly assess fire hazard, but it should be recognised that a single test method will not provide a full assessment of fire hazard under all conditions.

Due to the nature of fire testing and the consequent difficulty in quantifying the uncertainty of measurement, it is not possible to provide a stated degree of accuracy. The inherent variability in test procedures, materials and methods of construction, and installation may lead to variations in performance between elements of similar construction.

This assessment is based on information and experience available at the time of preparation. The published procedures for the conduct of tests and the assessment of test results are subject to constant review and improvement. It is therefore recommended that this report be reviewed on, or before, the stated expiry date.

This assessment represents our opinion about the performance likely to be demonstrated on a test in accordance with AS 1530.4:2014, based on the evidence referred to in this report.

This assessment is provided to Polyseam Ltd for their own specific purposes. Building certifiers and other third parties are responsible for deciding if they accept this assessment in a particular context.



## Appendix A Drawings and additional information

Table 53 Details of figures

Figures	Source
All drawings of construction details and graphical representation of intermediate service diameters and wall thicknesses as provided in section 6.	Extracted from the European Technical Assessment ETA-21/0071 of 2021/01/01 provided by Polyseam Ltd.

## Appendix B Summary of supporting test data

### B.1 Test report – WF 416697

**Table 54** Information about test report

Item	Information about test report
Report sponsor	Polyseam Ltd, St Andrews Road, Huddersfield, West Yorkshire, HD1, 6SB, UK.
Test laboratory	Warringtonfire, Chiltern House, Stocking Lane, High Wycombe, HP14, 4ND, UK.
Test date	The fire resistance test was completed on 14 August 2019.
Test standards	The test was done in accordance with BS EN 1363-1:2012 and BS EN 1366-3:2009.
Variation to test standards	None.
General description of tested specimen	The supporting construction comprised of a 100 mm thick reinforced AAC lintel ring beam built on top of a 1.5 m × 1.5 m furnace aperture. The aperture was 1100 mm high × 1100 mm wide × 100 mm deep and filled with Protecta EX Mortar fitted flush with the exposed face of the supporting construction.
Instrumentation	The test report states that the instrumentation was in accordance with BS EN 1363-1:2012 and BS EN 1366-3:2009.

The test specimen achieved the following results – see Table 55.

**Table 55** Results summary for this test report

Specimen	Aperture	FRL
Protecta EX Mortar fitted flush with the exposed face of the supporting construction.	1100 mm high × 1100 mm wide × 100 mm deep	-/240/240

## B.2 Test report – WF 394948

**Table 56 Information about test report**

Item	Information about test report
Report sponsor	Polyseam Ltd, St Andrews Road, Huddersfield, West Yorkshire, HD1, 6SB, UK.
Test laboratory	Warringtonfire, Chiltern House, Stocking Lane, High Wycombe, HP14, 4ND, UK.
Test date	The fire resistance test was completed on 30 January 2018.
Test standards	The test was done in accordance with BS EN 1363-1:2012 and BS EN 1366-3:2009.
Variation to test standards	None.
General description of tested specimen	The supporting construction comprised of a 150 mm thick reinforced AAC lintel ring beam built on top of a 1.5 m × 1.5 m furnace aperture. The services referenced in this assessment report are J1-J3. All pipes and cables measured 1200 mm long with a minimum of 500 mm protruding from the exposed face. J1-J3 were tested capped on both faces.
Instrumentation	The test report states that the instrumentation was in accordance with BS EN 1363-1:2012 and BS EN 1366-3:2009.

The test specimen achieved the following results – see Table 57.

**Table 57 Results summary for this test report**

Specimen	Aperture	Seal description	Service insulation	FRL
J1 - Geberit Mepla Alupex pipe with an outer diameter of 75 mm and a pipe wall thickness of 4.6 mm	Ø 175 mm	Pipe capping: C/C Protecta EX Mortar 50 mm thick cast around pipe. 50 mm thick Stonewool mineral fibre insulation batt (140 kg/m <sup>3</sup> density) fitted flush with the exposed face.	50 mm thick Isover CLIMPIPE section Alu2 glaswool insulation	-/120/120
J2 - Geberit Mepla Alupex pipe with an outer diameter of 16 mm and a pipe wall thickness of 2.25 mm	Ø 56 mm	Pipe capping: C/C Protecta EX Mortar 50 mm thick cast around pipe. 50 mm thick Stonewool mineral fibre insulation batt (140 kg/m <sup>3</sup> density) fitted flush with the exposed face.	20 mm thick Isover CLIMPIPE section Alu2 glaswool insulation	-/180/180
J3 - Geberit Mepla Alupex pipe with an outer diameter of 75 mm and a pipe wall thickness of 4.6 mm	Ø 125 mm	Pipe capping: C/C Protecta EX Mortar 50 mm thick cast around pipe. 50 mm thick Stonewool mineral fibre insulation batt (140 kg/m <sup>3</sup> density) fitted flush with the exposed face.	25 mm thick Isover CLIMPIPE section Alu2 glaswool insulation	-/180/180

## B.3 Test report – WF 405610

**Table 58 Information about test report**

Item	Information about test report
Report sponsor	Polyseam Ltd, St Andrews Road, Huddersfield, West Yorkshire, HD1, 6SB, UK.
Test laboratory	Warringtonfire, Chiltern House, Stocking Lane, High Wycombe, HP14, 4ND, UK.
Test date	The fire resistance test was completed on 11 October 2018.
Test standards	The test was done in accordance with BS EN 1363-1:2012 and BS EN 1366-3:2009.
Variation to test standards	None.
General description of tested specimen	The supporting construction comprised of a 150 mm thick reinforced AAC lintel ring beam built on top of a 1.5 m × 1.5 m furnace aperture. The services referenced in this assessment report are G1-G4. All pipes and cables measured 1200 mm long with a minimum of 500 mm protruding from the exposed face. G1 was tested capped on the exposed face and G2-G4 were tested capped on both faces.
Instrumentation	The test report states that the instrumentation was in accordance with BS EN 1363-1:2012 and BS EN 1366-3:2009.

The test specimen achieved the following results – see Table 59.

**Table 59 Results summary for this test report**

Specimen	Aperture	Seal description	Service insulation	FRL
G1 - Steel pipe with an outer diameter of 324 mm and a pipe wall thickness of 6.35 mm	Ø 324 mm	Pipe capping: C/U Protecta EX Mortar 50 mm thick cast around pipe. 50 mm thick Stonewool mineral fibre insulation batt (140 kg/m <sup>3</sup> density) fitted flush with the exposed face.	None	-/240/-
G2 - Copper pipe with an outer diameter of 12 mm and a pipe wall thickness of 0.7 mm	Ø 12 mm	Pipe capping: C/C Protecta EX Mortar 50 mm thick cast around pipe. 50 mm thick Stonewool mineral fibre insulation batt (140 kg/m <sup>3</sup> density) fitted flush with the exposed face.	None	-/240/30
G3 - Copper pipe with an outer diameter of 54 mm and a pipe wall thickness of 0.7 mm	Ø 54 mm	Pipe capping: C/C Protecta EX Mortar 50 mm thick cast around pipe. 50 mm thick Stonewool mineral fibre insulation batt (140 kg/m <sup>3</sup> density) fitted flush with the exposed face.	None	-/240/-
G3 – Gerberit Mepla (MLC) pipe with an outer diameter of 75 mm and a pipe wall thickness of 4.6 mm	Ø 75 mm	Pipe capping: C/C Protecta EX Mortar 50 mm thick cast around pipe. 50 mm thick Stonewool mineral fibre insulation batt (140 kg/m <sup>3</sup> density) fitted flush with the exposed face.	None	-/180/30

## B.4 Test report – WF 405532 Revision A

**Table 60** Information about test report

Item	Information about test report
Report sponsor	Polyseam Ltd, St Andrews Road, Huddersfield, West Yorkshire, HD1, 6SB, UK.
Test laboratory	Warringtonfire, Chiltern House, Stocking Lane, High Wycombe, HP14, 4ND, UK.
Test date	The fire resistance test was completed on 8 October 2018.
Test standards	The test was done in accordance with BS EN 1363-1:2012 and BS EN 1366-3:2009.
Variation to test standards	None.
General description of tested specimen	The supporting construction comprised of a 150 mm thick reinforced AAC lintel ring beam built on top of a 1.5 m × 1.5 m furnace aperture. The services referenced in this assessment report are A1-A4, C1, C3 and D1-D3. All pipes and cables measured 1200 mm long with a minimum of 500 mm protruding from the exposed face.
Instrumentation	The test report states that the instrumentation was in accordance with BS EN 1363-1:2012 and BS EN 1366-3:2009.

The test specimen achieved the following results – see Table 61.

**Table 61** Results summary for this test report

Specimen	Aperture	Seal description	Service insulation	FRL
A1 – PE pipe with an outer diameter of 50 mm and a pipe wall thickness of 4.6 mm	Ø 68 mm	Pipe capping: C/C Protecta EX Mortar 100 mm thick cast around pipe. Two layers of Protecta FR wrap, fitted flush with the exposed face of the fire seal (size 50 mm wide × 1.8 mm thick each layer. Overall, 3.6 mm thick)	9 mm thick Kaiflex ST	-/240/240
A2 – PP pipe with an outer diameter of 50 mm and a pipe wall thickness of 4.6 mm	Ø 68 mm	Pipe capping: C/C Protecta EX Mortar 100 mm thick cast around pipe. Two layers of Protecta FR wrap, fitted flush with the exposed face of the fire seal (size 50 mm wide × 1.8 mm thick each layer. Overall, 3.6 mm thick)	9 mm thick Kaiflex ST	-/240/180
A3 – PE pipe with an outer diameter of 50 mm and a pipe wall thickness of 3.0 mm	Ø 68 mm	Pipe capping: C/C Protecta EX Mortar 100 mm thick cast around pipe. Two layers of Protecta FR wrap, fitted flush with the exposed face of the fire seal (size 50 mm wide × 1.8 mm thick each layer. Overall, 3.6 mm thick)	9 mm thick Kaiflex ST	-/240/240
A4 – PP pipe with an outer diameter of 50 mm and a pipe wall thickness of 1.8 mm	Ø 68 mm	Pipe capping: C/C Protecta EX Mortar 100 mm thick cast around pipe. Two layers of Protecta FR wrap, fitted flush with the exposed face of the fire seal (size 50 mm wide × 1.8 mm thick)	9 mm thick Kaiflex ST	-/240/180

Specimen	Aperture	Seal description	Service insulation	FRL
		each layer. Overall, 3.6 mm thick)		
C1 – PE pipe with an outer diameter of 160 mm and a pipe wall thickness of 4.9 mm	Ø 178 mm	Pipe capping: C/C Protecta EX Mortar 120 mm thick cast around pipe. 6 layers of Protecta FR wrap, fitted flush with the exposed face of the fire seal (size 75 mm wide × 1.8 mm thick each layer. Overall, 10.8 mm thick)	9 mm thick Kaiflex ST	-/240/240
C3 – PE pipe with an outer diameter of 160 mm and a pipe wall thickness of 9.5 mm	Ø 178 mm	Pipe capping: C/C Protecta EX Mortar 120 mm thick cast around pipe. 6 layers of Protecta FR wrap, fitted flush with the exposed face of the fire seal (size 75 mm wide × 1.8 mm thick each layer. Overall, 10.8 mm thick)	9 mm thick Kaiflex ST	-/240/240
D1 – PP pipe with an outer diameter of 160 mm and a pipe wall thickness of 4.9 mm	Ø 178 mm	Pipe capping: C/C Protecta EX Mortar 120 mm thick cast around pipe. 6 layers of Protecta FR wrap, fitted flush with the exposed face of the fire seal (size 75 mm wide × 1.8 mm thick each layer. Overall, 10.8 mm thick)	9 mm thick Kaiflex ST	-/240/240
D2 – Copper pipe with an outer diameter of 12 mm and a pipe wall thickness of 0.7 mm	Ø 12 mm	Pipe capping: C/C Protecta EX Mortar 120 mm thick cast around pipe.	None.	-/240/180
D3 – PP pipe with an outer diameter of 160 mm and a pipe wall thickness of 9.1 mm	Ø 178 mm	Pipe capping: C/C Protecta EX Mortar 120 mm thick cast around pipe. 6 layers of Protecta FR wrap, fitted flush with the exposed face of the fire seal (size 75 mm wide × 1.8 mm thick each layer. Overall, 10.8 mm thick)	9 mm thick Kaiflex ST	-/240/240

## B.5 Test report – WF 400805

**Table 62 Information about test report**

Item	Information about test report
Report sponsor	Polyseam Ltd, St Andrews Road, Huddersfield, West Yorkshire, HD1, 6SB, UK.
Test laboratory	Warringtonfire, Chiltern House, Stocking Lane, High Wycombe, HP14, 4ND, UK.
Test date	The fire resistance test was completed on 8 November 2018.
Test standards	The test was done in accordance with BS EN 1363-1:2012 and BS EN 1366-3:2009.
Variation to test standards	None.
General description of tested specimen	The supporting construction comprised of a 150 mm thick reinforced AAC lintel ring beam built on top of a 1.5 m × 1.5 m furnace aperture. The services referenced in this assessment report are C1-C3. All pipes and cables measured 1200 mm long with a minimum of 500 mm protruding from the exposed face. Pipes C1 and C3 were tested capped on the unexposed face. Pipe C2 was tested uncapped on both faces.
Instrumentation	The test report states that the instrumentation was in accordance with BS EN 1363-1:2012 and BS EN 1366-3:2009.

The test specimen achieved the following results – see Table 63.

**Table 63 Results summary for this test report**

Specimen	Aperture	Seal description	Service insulation	FRL
C1 – Blue Power Multiplayer pipe with an outer diameter of 110 mm and a pipe wall thickness of 3.4 mm	Pipe and FR Wrap cast into EX Mortar	Pipe capping: U/C Protecta EX Mortar 100 mm thick cast around pipe. Two layers of Protecta FR wrap, fitted flush with the exposed face of the fire seal (size 50 mm wide × 1.8 mm thick each layer. Overall, 3.6 mm thick)	None.	-/120/120
C2 – Blue Power Multiplayer pipe with an outer diameter of 50 mm and a pipe wall thickness of 1.8 mm	Pipe and FR Wrap cast into EX Mortar	Pipe capping U/U Protecta EX Mortar 100 mm thick cast around pipe. Two layers of Protecta FR wrap, fitted flush with the exposed face of the fire seal (size 50 mm wide × 1.8 mm thick each layer. Overall, 3.6 mm thick)	None.	-/240/240
C3 – Blue Power Multiplayer pipe with an outer diameter of 160 mm and a pipe wall thickness of 4.9 mm	Pipe and FR Wrap cast into EX Mortar	Pipe capping U/U Protecta EX Mortar 100 mm thick cast around pipe. 6 layers of Protecta FR wrap, fitted flush with the exposed face of the fire seal (size 50 mm wide × 1.8 mm thick each layer. Overall, 10.6 mm thick)	None.	-/240/240

## B.6 Test report – WF 400806

**Table 64 Information about test report**

Item	Information about test report
Report sponsor	Polyseam Ltd, St Andrews Road, Huddersfield, West Yorkshire, HD1, 6SB, UK.
Test laboratory	Warringtonfire, Chiltern House, Stocking Lane, High Wycombe, HP14, 4ND, UK.
Test date	The fire resistance test was completed on 25 October 2018.
Test standards	The test was done in accordance with BS EN 1363-1:2012 and BS EN 1366-3:2009.
Variation to test standards	None.
General description of tested specimen	The supporting construction comprised of a 150 mm thick reinforced AAC lintel ring beam built on top of a 1.5 m × 1.5 m furnace aperture. The services referenced in this assessment report are G1-G4. All pipes and cables measured 1200 mm long with a minimum of 500 mm protruding from the exposed face. Pipes G1-G4 were tested capped on both faces.
Instrumentation	The test report states that the instrumentation was in accordance with BS EN 1363-1:2012 and BS EN 1366-3:2009.

The test specimen achieved the following results – see Table 65.

**Table 65 Results summary for this test report**

Specimen	Aperture	Seal description	Service insulation	FRL
G1 – PVC pipe with an outer diameter of 200 mm and a pipe wall thickness of 11.9 mm	Pipe and FR Wrap cast into EX Mortar	Pipe capping: C/C Protecta EX Mortar 100 mm thick cast around pipe. 6 layers of Protecta FR wrap, fitted flush with the exposed face of the fire seal (size 75 mm wide × 1.8 mm thick each layer. Overall, 10.8 mm thick)	None.	-/240/240
G2 – PE pipe with an outer diameter of 200 mm and a pipe wall thickness of 18.2 mm	Pipe and FR Wrap cast into EX Mortar	Pipe capping: C/C Protecta EX Mortar 100 mm thick cast around pipe. 6 layers of Protecta FR wrap, fitted flush with the exposed face of the fire seal (size 75 mm wide × 1.8 mm thick each layer. Overall, 10.8 mm thick)	None.	-/240/240
G3 – PVC pipe with an outer diameter of 200 mm and a pipe wall thickness of 4.9 mm	Pipe and FR Wrap cast into EX Mortar	Pipe capping: C/C Protecta EX Mortar 100 mm thick cast around pipe. 6 layers of Protecta FR wrap, fitted flush with the exposed face of the fire seal (size 75 mm wide × 1.8 mm thick each layer. Overall, 10.8 mm thick)	None.	-/240/240
G4 – PE pipe with an outer diameter of 200 mm and a pipe wall thickness of 6.2 mm	Pipe and FR Wrap cast into EX Mortar	Pipe capping: C/C Protecta EX Mortar 100 mm thick cast around pipe. 6 layers of Protecta FR wrap, fitted flush with the exposed face of the fire seal (size 75 mm wide × 1.8 mm thick)	None.	-/240/240



Specimen	Aperture	Seal description	Service insulation	FRL
		each layer. Overall, 10.8 mm thick)		

## B.7 Test report – WF 397686 Revision A

**Table 66** Information about test report

Item	Information about test report
Report sponsor	Polyseam Ltd, St Andrews Road, Huddersfield, West Yorkshire, HD1, 6SB, UK.
Test laboratory	Warringtonfire, Chiltern House, Stocking Lane, High Wycombe, HP14, 4ND, UK.
Test date	The fire resistance test was completed on 28 March 2018.
Test standards	The test was done in accordance with BS EN 1363-1:2012 and BS EN 1366-3:2009.
Variation to test standards	None.
General description of tested specimen	The supporting construction comprised of a 150 mm thick reinforced AAC lintel ring beam built on top of a 1.5 m × 1.5 m furnace aperture. The services referenced in this assessment report are E1 and E3. All pipes and cables measured 1200 mm long with a minimum of 500 mm protruding from the exposed face. Pipes E1 and E3 were tested capped on both faces.
Instrumentation	The test report states that the instrumentation was in accordance with BS EN 1363-1:2012 and BS EN 1366-3:2009.

The test specimen achieved the following results – see Table 67.

**Table 67** Results summary for this test report

Specimen	Aperture	Seal description	Service insulation	FRL
E1 – PP pipe with an outer diameter of 200 mm and a pipe wall thickness of 18.2 mm	Ø 200 mm	Pipe capping: C/C Protecta EX Mortar 120 mm thick cast around pipe. 6 layers of Protecta FR wrap, fitted flush with the exposed face of the fire seal (size 75 mm wide × 1.8 mm thick each layer. Overall, 10.8 mm thick)	None.	-/240/240
E3 – PP pipe with an outer diameter of 200 mm and a pipe wall thickness of 4.9 mm	Ø 200 mm	Pipe capping: C/C Protecta EX Mortar 120 mm thick cast around pipe. 6 layers of Protecta FR wrap, fitted flush with the exposed face of the fire seal (size 75 mm wide × 1.8 mm thick each layer. Overall, 10.8 mm thick)	None.	-/240/240

## B.8 Test report – WF 392115

**Table 68** Information about test report

Item	Information about test report
Report sponsor	Polyseam Ltd, St Andrews Road, Huddersfield, West Yorkshire, HD1, 6SB, UK.
Test laboratory	Warringtonfire, Chiltern House, Stocking Lane, High Wycombe, HP14, 4ND, UK.
Test date	The fire resistance test was completed on 16 November 2017.
Test standards	The test was done in accordance with BS EN 1363-1:2012 and BS EN 1366-3:2009.
Variation to test standards	None.
General description of tested specimen	The supporting construction comprised of a 150 mm thick reinforced AAC lintel ring beam built on top of a 1.5 m × 1.5 m furnace aperture. The service referenced in this assessment report is C. All pipes and cables measured 1200 mm long with a minimum of 500 mm protruding from the exposed face. Pipe C was tested capped on both faces.
Instrumentation	The test report states that the instrumentation was in accordance with BS EN 1363-1:2012 and BS EN 1366-3:2009.

The test specimen achieved the following results – see Table 69.

**Table 69** Results summary for this test report

Specimen	Aperture	Seal description	Service insulation	FRL
C – PVC pipe with an outer diameter of 400 mm and a pipe wall thickness of 15.3 mm	Ø 400 mm	Pipe capping: C/C Protecta EX Mortar 120 mm thick cast around pipe. 16 layers of Protecta FR wrap, fitted flush with the exposed face of the fire seal (size 75 mm wide × 1.8 mm thick each layer)	None.	-/60/60

## B.9 Test report – WF 19324A

**Table 70 Information about test report**

Item	Information about test report
Report sponsor	Polyseam Ltd, St Andrews Road, Huddersfield, West Yorkshire, HD1, 6SB, UK.
Test laboratory	WFRGENT NV, Ottergemsesteenweg-Zuid 711, B-9000, Gent, Belgie.
Test date	The fire resistance test was completed on 31 October 2018.
Test standards	The test was done in accordance with BS EN 1363-1:2012 and BS EN 1366-3:2009.
Variation to test standards	None.
General description of tested specimen	The supporting construction comprised of a 150 mm thick rigid aerated concrete floor with a minimum density of 550 kg/m <sup>3</sup> . The services referenced in this assessment report are B1-4, E1-E2, A11-A14 and AM. The service length is at least 500 mm on both sides of the supporting construction.
Instrumentation	The test report states that the instrumentation was in accordance with BS EN 1363-1:2012 and BS EN 1366-3:2009.

The test specimen achieved the following results – see Table 71.

**Table 71 Results summary for this test report**

Specimen	Aperture	Seal description	Service insulation	FRL
A11 – PE pipe with an outer diameter of 160 mm and a pipe wall thickness of 4.9 mm	700 mm × 900 mm	Pipe capping: C/C Protecta EX Mortar 120 mm thick cast around pipe. 10 layers of Protecta FR wrap, fitted flush with the exposed face of the fire seal (size 75 mm wide × 1.8 mm thick each layer, overall thickness 18 mm)	50 mm thick continuous sustained (CS) elastomeric insulation for the full length of the pipe	-/120/120
A12 – PE pipe with an outer diameter of 160 mm and a pipe wall thickness of 9.5 mm				
A13 – PP pipe with an outer diameter of 160 mm and a pipe wall thickness of 4.9 mm				
A14 – PP pipe with an outer diameter of 160 mm and a pipe wall thickness of 9.1 mm				
AM – Agru pipe with an outer diameter of 400 mm and a pipe wall thickness of 22.7 mm	600 mm × 600 mm	Pipe capping: C/C Protecta EX Mortar 150 mm thick cast around pipe. 16 layers of Protecta FR wrap, fitted flush with the exposed face of the fire seal (size 75 mm wide × 1.8 mm thick each layer, overall thickness 28.8 mm)	None	-/60/60
B1 – Steel pipe with an outer diameter of 76 mm and a pipe wall thickness of 1.5 mm	600 mm × 600 mm	Pipe capping: C/U Protecta EX Mortar 150 mm thick cast around pipe. 2 layers of Protecta FR wrap, fitted flush with the exposed face of the fire seal (size 50 mm wide × 1.8 mm thick each layer, overall thickness 3.6 mm)	30 mm thick PE foam insulation for continuous sustained for the full length of the pipe	-/180/90

Specimen	Aperture	Seal description	Service insulation	FRL
B2 – Steel pipe with an outer diameter of 76 mm and a pipe wall thickness of 1.5 mm		Pipe capping: C/U Protecta EX Mortar 150 mm thick cast around pipe. 1 layer of Protecta FR wrap, fitted flush with the exposed face of the fire seal (size 50 mm wide × 1.8 mm thick each layer, overall thickness 1.8 mm)	9 mm thick PE foam insulation for continuous sustained for the full length of the pipe	-/18060
B3 – Steel pipe with an outer diameter of 63.5 mm and a pipe wall thickness of 1.6 mm		Pipe capping: C/U Protecta EX Mortar 150 mm thick cast around pipe.		-/180/90
B4 – Steel pipe with an outer diameter of 12 mm and a pipe wall thickness of 1.0 mm		Pipe capping: C/U Protecta EX Mortar 150 mm thick cast around pipe. 1 layers of Protecta FR wrap, fitted flush with the exposed face of the fire seal (size 50 mm wide × 1.8 mm thick each layer, overall thickness 1.8 mm)	6 mm thick PE foam insulation for continuous sustained for the full length of the pipe	-/180/180
E1 – PP-MD Uponor Decibel pipe with an outer diameter of 110 mm and a pipe wall thickness of 3.8 mm	300 mm × 250 mm	Pipe capping: U/C Protecta EX Mortar 100 mm thick cast around pipe. 2 layers of Protecta FR wrap, fitted flush with the exposed face of the fire seal (size 50 mm wide × 1.8 mm thick each layer, overall thickness 3.6 mm)	None	-/120/120
E2 – PP-MD Uponor Decibel pipe with an outer diameter of 50 mm and a pipe wall thickness of 1.8 mm		Pipe capping: U/U Protecta EX Mortar 100 mm thick cast around pipe. 2 layers of Protecta FR wrap, fitted flush with the exposed face of the fire seal (size 50 mm wide × 1.8 mm thick each layer, overall thickness 3.6 mm)		

## B.10 Test report – WF 375797

**Table 72 Information about test report**

Item	Information about test report
Report sponsor	Polyseam Ltd, St Andrews Road, Huddersfield, West Yorkshire, HD1, 6SB, UK.
Test laboratory	Exova Warringtonfire, Holmesfield Road, Warrington, WA1, 2DS, UK
Test date	The fire resistance test was completed on 9 March 2017.
Test standards	The test was done in accordance with BS EN 1363-1:2012 and BS EN 1366-3:2009.
Variation to test standards	None.
General description of tested specimen	The supporting construction comprised of a 150 mm thick rigid aerated concrete floor with a minimum density of 550 kg/m <sup>3</sup> . The supporting construction had overall dimensions of 4000 mm length by 3000 mm width. The service referenced in this assessment report is A.
Instrumentation	The test report states that the instrumentation was in accordance with BS EN 1363-1:2012 and BS EN 1366-3:2009.

The test specimen achieved the following results – see Table 73.

**Table 73 Results summary for this test report**

Specimen	Seal type	FRL
A	2400 mm long by 1200 mm wide aperture which was sealed with 100 mm thick Polyseam “Protecta® Ex Mortar”. The Mortar was fit within the aperture flush to the exposed face of the supporting construction. The aperture was shuttered out with timber boards and braces with the mortar poured in.	-/240/240

## B.11 Test report – WF 375799A

**Table 74 Information about test report**

Item	Information about test report
Report sponsor	Polyseam Ltd, St Andrews Road, Huddersfield, West Yorkshire, HD1, 6SB, UK.
Test laboratory	Warringtonfire, Chiltern House, Stocking Lane, High Wycombe, HP14, 4ND, UK.
Test date	The fire resistance test was completed on 15 January 2016.
Test standards	The test was done in accordance with BS EN 1363-1:2012 and BS EN 1366-3:2009.
Variation to test standards	None.
General description of tested specimen	The supporting construction comprised a reinforced AAC lintel floor slab built on top of a 1.5 m × 1.5 m furnace aperture. The floor slab included 10 apertures. The services referenced in this assessment report are B, D, D1-D4, E1-E3. All pipes and cables measured nominally 1200mm long with a minimum of 500 mm protruding from the exposed face. All pipes were tested uncapped on both faces.
Instrumentation	The test report states that the instrumentation was in accordance with BS EN 1363-1:2012 and BS EN 1366-3:2009.

The test specimen achieved the following results – see Table 75.

**Table 75 Results summary for this test report**

Specimen	Aperture	Seal type	FRL
B – Blank seal	The aperture is 500 mm × 300 mm × 150 mm deep.	50 mm thick Protecta Ex Mortar. Backing material is 50 mm thick Stonewool rock fibre batt (140 kg/m <sup>3</sup> density) fitted flush with the exposed side.	-/240/90
D – Blank seal	The aperture is 200 mm × 200 mm × 150 mm deep.	100 mm thick Protecta Ex Mortar flush with the exposed face.	-/180/120
D1 – PVC pipe with an outer diameter of 40 mm and a pipe wall thickness of 3.7 mm	Ø 40 mm – pipe and intumescent cast into the fire seal	Pipe capping: U/U 100 mm thick Protecta Ex Mortar flush with the exposed face. Protecta FR Wrap 50 mm wide × 1.8 mm thick, fitted flush with the exposed face of the fire seal.	-/180/180
D2 – PE pipe with an outer diameter of 40 mm and a pipe wall thickness of 2.4 mm	Ø 40 mm – pipe and intumescent cast into the fire seal	Pipe capping: U/U 100 mm thick Protecta Ex Mortar flush with the exposed face. Protecta FR Wrap 50 mm wide × 1.8 mm thick, fitted flush with the exposed face of the fire seal.	-/240/240
D3 – PVC pipe with an outer diameter of 40 mm and a pipe wall thickness of 1.8 mm	Ø 40 mm – pipe and intumescent cast into the fire seal	Pipe capping: U/U 100 mm thick Protecta Ex Mortar flush with the exposed face. Protecta FR Wrap 50 mm wide × 1.8 mm thick, fitted flush with the exposed face of the fire seal.	-/180/120
D4 – PE pipe with an outer diameter of 40 mm and a pipe wall thickness of 3.7 mm	Ø 40 mm – pipe and intumescent cast into the fire seal	Pipe capping: U/U 100 mm thick Protecta Ex Mortar flush with the exposed face. Protecta FR Wrap 50 mm wide × 1.8 mm thick, fitted flush with the exposed face of the fire seal.	-/240/240
E1 – PVC pipe with an outer diameter of 160 mm and a pipe wall thickness of 4.0 mm	Ø 160 mm – pipe and intumescent cast into the fire seal	Pipe capping: U/U 100 mm thick Protecta Ex Mortar flush with the exposed face. Protecta FR Wrap 50 mm wide × 10.8 mm thick, fitted flush with the exposed face of the fire seal.	-/30/-

Specimen	Aperture	Seal type	FRL
E2 – PP pipe with an outer diameter of 160 mm and a pipe wall thickness of 14.6 mm	Ø 160 mm – pipe and intumescent cast into the fire seal	Pipe capping: U/U 100 mm thick Protecta Ex Mortar flush with the exposed face. Protecta FR Wrap 50 mm wide × 10.8 mm thick, fitted flush with the exposed face of the fire seal.	No FRL can be provided.
E3 – PP pipe with an outer diameter of 160 mm and a pipe wall thickness of 4.9 mm	Ø 160 mm – pipe and intumescent cast into the fire seal	Pipe capping: U/U 100 mm thick Protecta Ex Mortar flush with the exposed face. Protecta FR Wrap 50 mm wide × 10.8 mm thick, fitted flush with the exposed face of the fire seal.	No FRL can be provided.



## B.12 Test report – WF 375799B

**Table 76 Information about test report**

Item	Information about test report
Report sponsor	Polyseam Ltd, St Andrews Road, Huddersfield, West Yorkshire, HD1, 6SB, UK.
Test laboratory	Warringtonfire, Chiltern House, Stocking Lane, High Wycombe, HP14, 4ND, UK.
Test date	The fire resistance test was completed on 23 March 2017.
Test standards	The test was done in accordance with BS EN 1363-1:2012 and BS EN 1366-3:2009.
Variation to test standards	None.
General description of tested specimen	The supporting construction comprised a reinforced AAC lintel floor slab built on top of a 1.5 m × 1.5 m furnace aperture. The floor slab included 10 apertures. The services referenced in this assessment report are B, D, D1-D4, E, E1-E3. All pipes and cables measured nominally 1200mm long with a minimum of 500 mm protruding from the exposed face.
Instrumentation	The test report states that the instrumentation was in accordance with BS EN 1363-1:2012 and BS EN 1366-3:2009.

The test specimen achieved the following results – see Table 77.

**Table 77 Results summary for this test report**

Specimen	Aperture	Seal type	FRL
B – Blank seal	The aperture is 500 mm × 300 mm × 150 mm deep.	50 mm thick Protecta Ex Mortar. Backing material is 50 mm thick Stonewool rock fibre batt (140 kg/m <sup>3</sup> density) fitted flush with the exposed side.	-/180/120
D – Blank seal	The aperture is 500 mm × 500 mm × 150 mm deep.	100 mm thick Protecta Ex Mortar flush with the exposed face.	-/180/60
D1 – PE pipe with an outer diameter of 110 mm and a pipe wall thickness of 3.4 mm	Ø 110 mm – pipe and intumescent cast into the fire seal	Pipe capping: U/C 100 mm thick Protecta Ex Mortar flush with the exposed face. 2 layers of Protecta FR Wrap 50 mm wide × 1.8 mm thick, fitted flush with the exposed face of the fire seal.	-/120/120
D2 – PVC pipe with an outer diameter of 125 mm and a pipe wall thickness of 7.4 mm	Ø 125 mm – pipe and intumescent cast into the fire seal	Pipe capping: U/C 100 mm thick Protecta Ex Mortar flush with the exposed face. 4 layers of Protecta FR Wrap 50 mm wide × 1.8 mm thick, fitted flush with the exposed face of the fire seal.	-/120/120
D3 – PVC pipe with an outer diameter of 160 mm and a pipe wall thickness of 9.5 mm	Ø 160 mm – pipe and intumescent cast into the fire seal	Pipe capping: U/C 100 mm thick Protecta Ex Mortar flush with the exposed face. 6 layers of Protecta FR Wrap 50 mm wide × 1.8 mm thick, fitted flush with the exposed face of the fire seal.	-/60/60
D4 – PE pipe with an outer diameter of 160 mm and a pipe wall thickness of 4.9 mm	Ø 160 mm – pipe and intumescent cast into the fire seal	Pipe capping: U/C 100 mm thick Protecta Ex Mortar flush with the exposed face. 6 layers of Protecta FR Wrap 50 mm wide × 1.8 mm thick, fitted flush with the exposed face of the fire seal.	-/120/120

Specimen	Aperture	Seal type	FRL
E – Blank seal	The aperture is 200 mm × 200 mm × 150 mm deep.	100 mm thick Protecta Ex Mortar flush with the exposed face.	-/120/90
E1 – PVC pipe with an outer diameter of 40 mm and a pipe wall thickness of 1.9 mm	Ø 40 mm – pipe and intumescent cast into the fire seal	Pipe capping: U/U 100 mm thick Protecta Ex Mortar flush with the exposed face. Protecta FR Wrap 50 mm wide × 1.8 mm thick, fitted flush with the exposed face of the fire seal.	-/120/120
E2 – PE pipe with an outer diameter of 40 mm and a pipe wall thickness of 2.4 mm	Ø 40 mm – pipe and intumescent cast into the fire seal	Pipe capping: U/U 100 mm thick Protecta Ex Mortar flush with the exposed face. Protecta FR Wrap 50 mm wide × 1.8 mm thick, fitted flush with the exposed face of the fire seal.	-/180/90
E3 – PP pipe with an outer diameter of 40 mm and a pipe wall thickness of 5.5 mm	Ø 40 mm – pipe and intumescent cast into the fire seal	Pipe capping: U/U 100 mm thick Protecta Ex Mortar flush with the exposed face. Protecta FR Wrap 50 mm wide × 1.8 mm thick, fitted flush with the exposed face of the fire seal.	-/120/120

## B.13 Test report – WF 379319

**Table 78 Information about test report**

Item	Information about test report
Report sponsor	Polyseam Ltd, St Andrews Road, Huddersfield, West Yorkshire, HD1, 6SB, UK.
Test laboratory	Warringtonfire, Chiltern House, Stocking Lane, High Wycombe, HP14, 4ND, UK.
Test date	The fire resistance test was completed on 2 February 2017.
Test standards	The test was done in accordance with BS EN 1363-1:2012 and BS EN 1366-3:2009.
Variation to test standards	None.
General description of tested specimen	The supporting construction comprised a reinforced AAC lintel floor slab built on top of a 1.5 m × 1.5 m furnace aperture. The floor slab included 10 apertures. The services referenced in this assessment report are A, A1-A3, B1, B4, C1-C2, C4, D, D1-D3. All pipes and cables measured nominally 1200 mm long with a minimum of 500 mm protruding from the exposed face.
Instrumentation	The test report states that the instrumentation was in accordance with BS EN 1363-1:2012 and BS EN 1366-3:2009.

The test specimen achieved the following results – see Table 79.

**Table 79 Results summary for this test report**

Specimen	Aperture	Seal type	FRL
A – Blank seal	The aperture is 450 mm × 450 mm × 150 mm deep.	100 mm thick Protecta Ex Mortar flush with the exposed face.	-/30/-
A1 – PP pipe with an outer diameter of 160 mm and a pipe wall thickness of 14.6 mm	Ø 160 mm – pipe and intumescent cast into the fire seal	Pipe capping: U/C 100 mm thick Protecta Ex Mortar flush with the exposed face. 6 layers of Protecta FR Wrap 50 mm wide × 1.8 mm thick, fitted flush with the exposed face of the fire seal.	-/240/240
A2 – PVC pipe with an outer diameter of 110 mm and a pipe wall thickness of 2.7 mm	Ø 110 mm – pipe and intumescent cast into the fire seal	Pipe capping: U/U 100 mm thick Protecta Ex Mortar flush with the exposed face. 2 layers of Protecta FR Wrap 50 mm wide × 1.8 mm thick, fitted flush with the exposed face of the fire seal.	-/30/-
A3 – PE pipe with an outer diameter of 125 mm and a pipe wall thickness of 3.9 mm	Ø 125 mm – pipe and intumescent cast into the fire seal	Pipe capping: U/U 100 mm thick Protecta Ex Mortar flush with the exposed face. 4 layers of Protecta FR Wrap 50 mm wide × 1.8 mm thick, fitted flush with the exposed face of the fire seal.	-/240/-
B1 – PE pipe with an outer diameter of 125 mm and a pipe wall thickness of 11.4 mm	Ø 125 mm – pipe and intumescent cast into the fire seal	Pipe capping: U/U 100 mm thick Protecta Ex Mortar flush with the exposed face. 4 layers of Protecta FR Wrap 50 mm wide × 1.8 mm thick, fitted flush with the exposed face of the fire seal.	-/240/240
B4 – PVC pipe with an outer diameter of 110 mm and a pipe wall thickness of 6.3 mm	Ø 110 mm – pipe and intumescent cast into the fire seal	Pipe capping: U/U 100 mm thick Protecta Ex Mortar flush with the exposed face. 2 layers of Protecta FR Wrap 50 mm wide × 1.8 mm thick, fitted flush with the exposed face of the fire seal.	-/120/30

Specimen	Aperture	Seal type	FRL
C1 – PVC pipe with an outer diameter of 125 mm and a pipe wall thickness of 7.4 mm	Ø 125 mm – pipe and intumescent cast into the fire seal	Pipe capping: U/U 100 mm thick Protecta Ex Mortar flush with the exposed face. 4 layers of Protecta FR Wrap 50 mm wide × 1.8 mm thick, fitted flush with the exposed face of the fire seal.	-/30/30
C2 – PP pipe with an outer diameter of 125 mm and a pipe wall thickness of 11.4 mm	Ø 125 mm – pipe and intumescent cast into the fire seal	Pipe capping: U/U 100 mm thick Protecta Ex Mortar flush with the exposed face. 4 layers of Protecta FR Wrap 50 mm wide × 1.8 mm thick, fitted flush with the exposed face of the fire seal.	-/240/240
C4 – PE pipe with an outer diameter of 110 mm and a pipe wall thickness of 3.4 mm	Ø 110 mm – pipe and intumescent cast into the fire seal	Pipe capping: U/U 100 mm thick Protecta Ex Mortar flush with the exposed face. 2 layers of Protecta FR Wrap 50 mm wide × 1.8 mm thick, fitted flush with the exposed face of the fire seal.	-/240/-
D – Blank seal	The aperture is 450 mm × 450 mm × 150 mm deep.	100 mm thick Protecta Ex Mortar flush with the exposed face.	-/60/60
D1 – PVC pipe with an outer diameter of 125 mm and a pipe wall thickness of 4.8 mm	Ø 125 mm – pipe and intumescent cast into the fire seal	Pipe capping: U/U 100 mm thick Protecta Ex Mortar flush with the exposed face. 4 layers of Protecta FR Wrap 50 mm wide × 1.8 mm thick, fitted flush with the exposed face of the fire seal.	-/60/60
D2 – PP pipe with an outer diameter of 160 mm and a pipe wall thickness of 4.9 mm	Ø 160 mm – pipe and intumescent cast into the fire seal	Pipe capping: U/C 100 mm thick Protecta Ex Mortar flush with the exposed face. 6 layers of Protecta FR Wrap 50 mm wide × 1.8 mm thick, fitted flush with the exposed face of the fire seal.	-/240/240
D3 – PE pipe with an outer diameter of 110 mm and a pipe wall thickness of 10.0 mm	Ø 110 mm – pipe and intumescent cast into the fire seal	Pipe capping: U/U 100 mm thick Protecta E Mortar flush with the exposed face. 2 layers of Protecta FR Wrap 50 mm wide × 1.8 mm thick, fitted flush with the exposed face of the fire seal.	-/240/240

## B.14 Test report – WF 380963

**Table 80 Information about test report**

Item	Information about test report
Report sponsor	Polyseam Ltd, St Andrews Road, Huddersfield, West Yorkshire, HD1, 6SB, UK.
Test laboratory	Warringtonfire, Chiltern House, Stocking Lane, High Wycombe, HP14, 4ND, UK.
Test date	The fire resistance test was completed on 6 March 2017.
Test standards	The test was done in accordance with BS EN 1363-1:2012 and BS EN 1366-3:2009.
Variation to test standards	None.
General description of tested specimen	The supporting construction comprised a reinforced AAC lintel floor slab built on top of a 1.5 m × 1.5 m furnace aperture. The floor slab included 10 apertures. The services referenced in this assessment report are J, J1-J9. All pipes and cables measured nominally 1200 mm long with a minimum of 500 mm protruding from the exposed face.
Instrumentation	The test report states that the instrumentation was in accordance with BS EN 1363-1:2012 and BS EN 1366-3:2009.

The test specimen achieved the following results – see Table 81.

**Table 81 Results summary for this test report**

Specimen	Aperture	Seal type	FRL
J – Blank seal	The aperture is 750 mm × 400 mm × 150 mm deep.	100 mm thick Protecta Ex Mortar flush with the exposed face.	-/60/60
J1 – PE pipe with an outer diameter of 40 mm and a pipe wall thickness of 4.4 mm	Ø 40 mm – pipe and intumescent cast into the fire seal	Pipe capping: U/C 100 mm thick Protecta Ex Mortar flush with the exposed face.	-/180/120
J2 – PP pipe with an outer diameter of 40 mm and a pipe wall thickness of 1.8 mm	Ø 40 mm – pipe and intumescent cast into the fire seal	Pipe capping: U/C 100 mm thick Protecta Ex Mortar flush with the exposed face.	-/120/120
J3 – PHP pipe with an outer diameter of 20 mm and a pipe wall thickness of 2.2 mm	Ø 20 mm – pipe and intumescent cast into the fire seal	Pipe capping: U/C 100 mm thick Protecta Ex Mortar flush with the exposed face.	-/180/180
J4 – PP pipe with an outer diameter of 40 mm and a pipe wall thickness of 4.4 mm	Ø 40 mm – pipe and intumescent cast into the fire seal	Pipe capping: U/C 100 mm thick Protecta Ex Mortar flush with the exposed face.	-/180/120
J5 – PE pipe with an outer diameter of 20 mm and a pipe wall thickness of 2.0 mm	Ø 20 mm – pipe and intumescent cast into the fire seal	Pipe capping: U/C 100 mm thick Protecta Ex Mortar flush with the exposed face.	-/120/120
J6 – PE pipe with an outer diameter of 40 mm and a pipe wall thickness of 3.0 mm	Ø 40 mm – pipe and intumescent cast into the fire seal	Pipe capping: U/C 100 mm thick Protecta Ex Mortar flush with the exposed face.	-/120/120
Cable transit J7 – Ø 90 mm Type F cable bundle through PP pipe with an outer diameter of 110 mm and a pipe wall thickness of 3.4 mm	Ø 110 mm – pipe and intumescent cast into the fire seal	Pipe capping: U/C 100 mm thick Protecta Ex Mortar flush with the exposed face. 2 layers of Protecta FR Wrap 50 mm wide × 1.8 mm thick, fitted flush with the exposed face of the fire seal.	-/60/60

Specimen	Aperture	Seal type	FRL
Cable transit J8 – Ø 90 mm Type F cable bundle through PE pipe with an outer diameter of 110 mm and a pipe wall thickness of 3.4 mm	Ø 110 mm – pipe and intumescent cast into the fire seal	Pipe capping: U/C 100 mm thick Protecta Ex Mortar flush with the exposed face. 2 layers of Protecta FR Wrap 50 mm wide × 1.8 mm thick, fitted flush with the exposed face of the fire seal.	-/120/60
Cable transit J9 – Ø 90 mm Type F cable bundle through PVC pipe with an outer diameter of 110 mm and a pipe wall thickness of 2.7 mm	Ø 110 mm – pipe and intumescent cast into the fire seal	Pipe capping: U/C 100 mm thick Protecta Ex Mortar flush with the exposed face. 2 layers of Protecta FR Wrap 50 mm wide × 1.8 mm thick, fitted flush with the exposed face of the fire seal.	-/120/120

## B.15 Test report – WF 382337

**Table 82 Information about test report**

Item	Information about test report
Report sponsor	Polyseam Ltd, St Andrews Road, Huddersfield, West Yorkshire, HD1, 6SB, UK.
Test laboratory	Warringtonfire, Chiltern House, Stocking Lane, High Wycombe, HP14, 4ND, UK.
Test date	The fire resistance test was completed on 19 April 2017.
Test standards	The test was done in accordance with BS EN 1363-1:2012 and BS EN 1366-3:2009.
Variation to test standards	None.
General description of tested specimen	The supporting construction comprised a reinforced AAC lintel floor slab built on top of a 1.5 m × 1.5 m furnace aperture. The floor slab included 10 apertures. All pipes and cables measured nominally 1200 mm long with a minimum of 500 mm protruding from the exposed face.
Instrumentation	The test report states that the instrumentation was in accordance with BS EN 1363-1:2012 and BS EN 1366-3:2009.

The test specimen achieved the following results – see Table 83.

**Table 83 Results summary for this test report**

Specimen	Aperture	Seal type	FRL
1 – Blank seal	The aperture is 450 mm × 450 mm × 150 mm deep.	100 mm thick Protecta Ex Mortar flush with the exposed face.	-/240/240
A1 – PE pipe with an outer diameter of 160 mm and a pipe wall thickness of 14.6 mm	Ø 160 mm – pipe and intumescent cast into the fire seal	Pipe capping: U/C 100 mm thick Protecta Ex Mortar flush with the exposed face. 6 layers of Protecta FR Wrap 50 mm wide × 1.8 mm thick, fitted flush with the exposed face of the fire seal.	-/240/240
A2 – PP pipe with an outer diameter of 110 mm and a pipe wall thickness of 2.7 mm	Ø 110 mm – pipe and intumescent cast into the fire seal	Pipe capping: U/C 100 mm thick Protecta Ex Mortar flush with the exposed face. 2 layers of Protecta FR Wrap 50 mm wide × 1.8 mm thick, fitted flush with the exposed face of the fire seal.	-/240/240
A3 – PP pipe with an outer diameter of 110 mm and a pipe wall thickness of 2.7 mm	Ø 110 mm – pipe and intumescent cast into the fire seal	Pipe capping: U/C 100 mm thick Protecta Ex Mortar flush with the exposed face. 2 layers of Protecta FR Wrap 50 mm wide × 1.8 mm thick, fitted flush with the exposed face of the fire seal.	-/240/240
2 – Blank seal	The aperture is 450 mm × 450 mm × 150 mm deep.	100 mm thick Protecta Ex Mortar flush with the exposed face.	-/240/240
B1 – PP pipe with an outer diameter of 40 mm and a pipe wall thickness of 1.8 mm	Ø 40 mm – pipe and intumescent cast into the fire seal	Pipe capping: U/U 100 mm thick Protecta Ex Mortar flush with the exposed face. 1 layer of Protecta FR Wrap 50 mm wide × 1.8 mm thick, fitted flush with the exposed face of the fire seal.	-/240/240
B2 – PP pipe with an outer diameter of 125 mm and a pipe wall thickness of 3.9 mm	Ø 125 mm – pipe and intumescent cast into the fire seal	Pipe capping: U/C 100 mm thick Protecta Ex Mortar flush with the exposed face. 4 layers of Protecta FR Wrap 50 mm wide × 1.8	-/240/240

Specimen	Aperture	Seal type	FRL
		mm thick, fitted flush with the exposed face of the fire seal.	
B3 – PP pipe with an outer diameter of 110 mm and a pipe wall thickness of 6.3 mm	Ø 110 mm – pipe and intumescent cast into the fire seal	Pipe capping: U/C 100 mm thick Protecta Ex Mortar flush with the exposed face. 2 layers of Protecta FR Wrap 50 mm wide × 1.8 mm thick, fitted flush with the exposed face of the fire seal.	-/240/240
B4 – PP pipe with an outer diameter of 125 mm and a pipe wall thickness of 11.4 mm	Ø 125 mm – pipe and intumescent cast into the fire seal	Pipe capping: U/C 100 mm thick Protecta Ex Mortar flush with the exposed face. 4 layers of Protecta FR Wrap 50 mm wide × 1.8 mm thick, fitted flush with the exposed face of the fire seal.	-/240/240
3 – Blank seal	The aperture is 450 mm × 450 mm × 150 mm deep.	50 mm thick Protecta Ex Mortar cast around the pipes over 50 mm thick rock mineral fibre (density is 140 kg/m <sup>3</sup> ) flush to the exposed face.	-/240/30
C1 – Diamond PE-Xb/AL/PE-Xb pipe with an outer diameter of 16 mm and a pipe wall thickness of 2.0 mm	Ø 16 mm – pipe and intumescent cast into the fire seal	Pipe capping: C/C 50 mm thick Protecta Ex Mortar cast around the pipes over 50 mm thick rock mineral fibre (density is 140 kg/m <sup>3</sup> ) flush to the exposed face.	-/240/240
C2 – Steel pipe with an outer diameter of 16 mm and a pipe wall thickness of 2.0 mm	Ø 16 mm – pipe and intumescent cast into the fire seal	Pipe capping: C/U 50 mm thick Protecta Ex Mortar cast around the pipes over 50 mm thick rock mineral fibre (density is 140 kg/m <sup>3</sup> ) flush to the exposed face.	-/240/240
C3 – Rodana PE-Xb/AL/PE-Xb pipe with an outer diameter of 20 mm and a pipe wall thickness of 2.0 mm	Ø 20 mm – pipe and intumescent cast into the fire seal	Pipe capping: C/C 50 mm thick Protecta Ex Mortar cast around the pipes over 50 mm thick rock mineral fibre (density is 140 kg/m <sup>3</sup> ) flush to the exposed face.	-/240/240
D1 – Copper pipe with an outer diameter of 6 mm and a pipe wall thickness of 0.7 mm	Ø 6 mm – pipe and intumescent cast into the fire seal	Pipe capping: C/C 50 mm thick Protecta Ex Mortar cast around the pipes over 50 mm thick rock mineral fibre (density is 140 kg/m <sup>3</sup> ) flush to the exposed face.	-/240/120
D2 – Copper pipe with an outer diameter of 15 mm and a pipe wall thickness of 0.9 mm	Ø 15 mm – pipe and intumescent cast into the fire seal	Pipe capping: C/C 50 mm thick Protecta Ex Mortar cast around the pipes over 50 mm thick rock mineral fibre (density is 140 kg/m <sup>3</sup> ) flush to the exposed face.	-/240/30
D3 – Steel pipe with an outer diameter of 4 mm and a pipe wall thickness of 1.0 mm	Ø 4 mm – pipe and intumescent cast into the fire seal	Pipe capping: C/U 50 mm thick Protecta Ex Mortar cast around the pipes over 50 mm thick rock mineral fibre (density is 140 kg/m <sup>3</sup> ) flush to the exposed face.	-/240/240
E1 – Copper pipe with an outer diameter of 12 mm and a pipe wall thickness of 0.7 mm	Ø 12 mm – pipe and intumescent cast into the fire seal	Pipe capping: C/C 50 mm thick Protecta Ex Mortar cast around the pipes over 50 mm thick rock mineral fibre (density is 140 kg/m <sup>3</sup> ) flush to the exposed face. 20 mm thick foil faced 80 kg/m <sup>3</sup> stonewool CS	-/240/240



Specimen	Aperture	Seal type	FRL
E2 – Copper pipe with an outer diameter of 54 mm and a pipe wall thickness of 1.2 mm	Ø 54 mm – pipe and intumescent cast into the fire seal	Pipe capping: C/C 50 mm thick Protecta Ex Mortar cast around the pipes over 50 mm thick rock mineral fibre (density is 140 kg/m <sup>3</sup> ) flush to the exposed face. 20 mm thick foil faced 80 kg/m <sup>3</sup> stonewool CS	-/240/120
E3 – Copper pipe with an outer diameter of 54 mm and a pipe wall thickness of 1.2 mm	Ø 54 mm – pipe and intumescent cast into the fire seal	Pipe capping: C/C 50 mm thick Protecta Ex Mortar cast around the pipes over 50 mm thick rock mineral fibre (density is 140 kg/m <sup>3</sup> ) flush to the exposed face. 80 mm thick foil faced 80 kg/m <sup>3</sup> stonewool CS	-/240/180
4 – Blank seal	The aperture is 450 mm × 450 mm × 150 mm deep.	100 mm thick Protecta Ex Mortar flush with the exposed face.	No FRL can be provided.
F1 – PVC pipe with an outer diameter of 90 mm and a pipe wall thickness of 2.8 mm	Ø 90 mm – pipe and intumescent cast into the fire seal	Pipe capping: U/U 100 mm thick Protecta Ex Mortar flush with the exposed face. 2 layers of Protecta FR Wrap 50 mm wide × 1.8 mm thick, fitted flush with the exposed face of the fire seal.	-/120/-
F2 – PP pipe with an outer diameter of 90 mm and a pipe wall thickness of 2.8 mm	Ø 90 mm – pipe and intumescent cast into the fire seal	Pipe capping: U/U 100 mm thick Protecta Ex Mortar flush with the exposed face. 2 layers of Protecta FR Wrap 50 mm wide × 1.8 mm thick, fitted flush with the exposed face of the fire seal.	No FRL can be provided.
F2 – PE pipe with an outer diameter of 90 mm and a pipe wall thickness of 2.8 mm	Ø 90 mm – pipe and intumescent cast into the fire seal	Pipe capping: U/U 100 mm thick Protecta Ex Mortar flush with the exposed face. 2 layers of Protecta FR Wrap 50 mm wide × 1.8 mm thick, fitted flush with the exposed face of the fire seal.	-/240/-
G1 – PE pipe with an outer diameter of 90 mm and a pipe wall thickness of 8.2 mm	Ø 90 mm – pipe and intumescent cast into the fire seal	Pipe capping: U/U 100 mm thick Protecta Ex Mortar flush with the exposed face. 2 layers of Protecta FR Wrap 50 mm wide × 1.8 mm thick, fitted flush with the exposed face of the fire seal.	-/240/240
G2 – PP pipe with an outer diameter of 90 mm and a pipe wall thickness of 8.2 mm	Ø 90 mm – pipe and intumescent cast into the fire seal	Pipe capping: U/U 100 mm thick Protecta Ex Mortar flush with the exposed face. 2 layers of Protecta FR Wrap 50 mm wide × 1.8 mm thick, fitted flush with the exposed face of the fire seal.	No FRL can be provided.
G3 – PVC pipe with an outer diameter of 90 mm and a pipe wall thickness of 6.7 mm	Ø 90 mm – pipe and intumescent cast into the fire seal	Pipe capping: U/U 100 mm thick Protecta Ex Mortar flush with the exposed face. 2 layers of Protecta FR Wrap 50 mm wide × 1.8 mm thick, fitted flush with the exposed face of the fire seal.	-/120/60

# warringtonfire

Proud to be part of  element



Warringtonfire Australia Pty Ltd  
ABN 81 050 241 524

#### Perth

Unit 22, 22 Railway Road  
Subiaco WA 6008  
Australia  
T: +61 8 9382 3844

#### Canberra

Unit 10, 71 Leichhardt Street  
Kingston ACT 2604  
Australia  
T: +61 2 6260 8488

#### Melbourne

Level 9, 401 Collins Street  
Melbourne VIC 3000  
Australia  
T: +61 3 9767 1000

#### Sydney

Suite 802, Level 8, 383 Kent Street  
Sydney NSW 2000  
Australia  
T: +61 2 9211 4333

#### Brisbane

Suite 6, Level 12, 133 Mary Street  
Brisbane QLD 4000  
Australia  
T: +61 7 3238 1700

#### Melbourne – NATA registered laboratory

409-411 Hammond Road  
Dandenong South VIC 3175  
Australia  
T: +61 3 9767 1000

#### General conditions of use

The data, methodologies, calculations and results documented in this report specifically relate to the tested specimen/s and must not be used for any other purpose. This report may only be reproduced in full. Extracts or abridgements must not be published without permission from Warringtonfire.

All work and services carried out by Warringtonfire are subject to, and conducted in accordance with our standard terms and conditions. These are available on request or at <https://www.element.com/terms/terms-and-conditions>.